

IEEE Recommended Practices for Modulating Current in High-Brightness LEDs for Mitigating Health Risks to Viewers

IEEE Power Electronics Society

Sponsored by the
Standards Committee

www.Lisungroup.cc

www.Lisungroup.cc

IEEE Recommended Practices for Modulating Current in High-Brightness LEDs for Mitigating Health Risks to Viewers

Sponsor

Standards Committee
of the
IEEE Power Electronics Society

Approved 26 March 2015

IEEE-SA Standards Board

www.Lisungroup.cc

Abstract: This document includes a definition of the concept of modulation frequencies for light-emitting diodes (LEDs), a discussion on their applications to LED lighting, a description of LED lighting applications in which modulation frequencies pose possible health risks to users, a discussion of the dimming of LEDs by modulating the frequency of driving currents/voltage, and recommendations for modulation frequencies (flicker) for LED lighting and dimming applications to help protect against known potential adverse health effects.

Keywords: flicker, headaches, health, IEEE 1789™, LED lighting, migraines, modulation, perception, power electronic drivers, seizure, stroboscopic

www.Lisungroup.cc

The Institute of Electrical and Electronics Engineers, Inc.
3 Park Avenue, New York, NY 10016-5997, USA

Copyright © 2015 by The Institute of Electrical and Electronics Engineers, Inc.
All rights reserved. Published 5 June 2015. Printed in the United States of America.

IEEE is a registered trademark in the U.S. Patent & Trademark Office, owned by The Institute of Electrical and Electronics Engineers, Incorporated.

PDF: ISBN 978-0-7381-9644-2 STD20178
Print: ISBN 978-0-7381-9645-9 STDPD20178

IEEE prohibits discrimination, harassment, and bullying.

For more information, visit <http://www.ieee.org/web/aboutus/whatis/policies/p9-26.html>.

No part of this publication may be reproduced in any form, in an electronic retrieval system or otherwise, without the prior written permission of the publisher.

Important Notices and Disclaimers Concerning IEEE Standards Documents

IEEE documents are made available for use subject to important notices and legal disclaimers. These notices and disclaimers, or a reference to this page, appear in all standards and may be found under the heading “Important Notice” or “Important Notices and Disclaimers Concerning IEEE Standards Documents.”

Notice and Disclaimer of Liability Concerning the Use of IEEE Standards Documents

IEEE Standards documents (standards, recommended practices, and guides), both full-use and trial-use, are developed within IEEE Societies and the Standards Coordinating Committees of the IEEE Standards Association (“IEEE-SA”) Standards Board. IEEE (“the Institute”) develops its standards through a consensus development process, approved by the American National Standards Institute (“ANSI”), which brings together volunteers representing varied viewpoints and interests to achieve the final product. Volunteers are not necessarily members of the Institute and participate without compensation from IEEE. While IEEE administers the process and establishes rules to promote fairness in the consensus development process, IEEE does not independently evaluate, test, or verify the accuracy of any of the information or the soundness of any judgments contained in its standards.

IEEE does not warrant or represent the accuracy or content of the material contained in its standards, and expressly disclaims all warranties (express, implied and statutory) not included in this or any other document relating to the standard, including, but not limited to, the warranties of: merchantability; fitness for a particular purpose; non-infringement; and quality, accuracy, effectiveness, currency, or completeness of material. In addition, IEEE disclaims any and all conditions relating to: results; and workmanlike effort. IEEE standards documents are supplied “AS IS” and “WITH ALL FAULTS.”

Use of an IEEE standard is wholly voluntary. The existence of an IEEE standard does not imply that there are no other ways to produce, test, measure, purchase, market, or provide other goods and services related to the scope of the IEEE standard. Furthermore, the viewpoint expressed at the time a standard is approved and issued is subject to change brought about through developments in the state of the art and comments received from users of the standard.

In publishing and making its standards available, IEEE is not suggesting or rendering professional or other services for, or on behalf of, any person or entity nor is IEEE undertaking to perform any duty owed by any other person or entity to another. Any person utilizing any IEEE Standards document, should rely upon his or her own independent judgment in the exercise of reasonable care in any given circumstances or, as appropriate, seek the advice of a competent professional in determining the appropriateness of a given IEEE standard.

IN NO EVENT SHALL IEEE BE LIABLE FOR ANY DIRECT, INDIRECT, INCIDENTAL, SPECIAL, EXEMPLARY, OR CONSEQUENTIAL DAMAGES (INCLUDING, BUT NOT LIMITED TO: PROCUREMENT OF SUBSTITUTE GOODS OR SERVICES; LOSS OF USE, DATA, OR PROFITS; OR BUSINESS INTERRUPTION) HOWEVER CAUSED AND ON ANY THEORY OF LIABILITY, WHETHER IN CONTRACT, STRICT LIABILITY, OR TORT (INCLUDING NEGLIGENCE OR OTHERWISE) ARISING IN ANY WAY OUT OF THE PUBLICATION, USE OF, OR RELIANCE UPON ANY STANDARD, EVEN IF ADVISED OF THE POSSIBILITY OF SUCH DAMAGE AND REGARDLESS OF WHETHER SUCH DAMAGE WAS FORESEEABLE.

Translations

The IEEE consensus development process involves the review of documents in English only. In the event that an IEEE standard is translated, only the English version published by IEEE should be considered the approved IEEE standard.

Official statements

A statement, written or oral, that is not processed in accordance with the IEEE-SA Standards Board Operations Manual shall not be considered or inferred to be the official position of IEEE or any of its committees and shall not be considered to be, or be relied upon as, a formal position of IEEE. At lectures, symposia, seminars, or educational courses, an individual presenting information on IEEE standards shall make it clear that his or her views should be considered the personal views of that individual rather than the formal position of IEEE.

Comments on standards

Comments for revision of IEEE Standards documents are welcome from any interested party, regardless of membership affiliation with IEEE. However, IEEE does not provide consulting information or advice pertaining to IEEE Standards documents. Suggestions for changes in documents should be in the form of a proposed change of text, together with appropriate supporting comments. Since IEEE standards represent a consensus of concerned interests, it is important that any responses to comments and questions also receive the concurrence of a balance of interests. For this reason, IEEE and the members of its societies and Standards Coordinating Committees are not able to provide an instant response to comments or questions except in those cases where the matter has previously been addressed. For the same reason, IEEE does not respond to interpretation requests. Any person who would like to participate in revisions to an IEEE standard is welcome to join the relevant IEEE working group.

Comments on standards should be submitted to the following address:

Secretary, IEEE-SA Standards Board
445 Hoes Lane
Piscataway, NJ 08854 USA

Laws and regulations

Users of IEEE Standards documents should consult all applicable laws and regulations. Compliance with the provisions of any IEEE Standards document does not imply compliance to any applicable regulatory requirements. Implementers of the standard are responsible for observing or referring to the applicable regulatory requirements. IEEE does not, by the publication of its standards, intend to urge action that is not in compliance with applicable laws, and these documents may not be construed as doing so.

Copyrights

IEEE draft and approved standards are copyrighted by IEEE under U.S. and international copyright laws. They are made available by IEEE and are adopted for a wide variety of both public and private uses. These include both use, by reference, in laws and regulations, and use in private self-regulation, standardization, and the promotion of engineering practices and methods. By making these documents available for use and adoption by public authorities and private users, IEEE does not waive any rights in copyright to the documents.

Photocopies

Subject to payment of the appropriate fee, IEEE will grant users a limited, non-exclusive license to photocopy portions of any individual standard for company or organizational internal use or individual, non-commercial use only. To arrange for payment of licensing fees, please contact Copyright Clearance Center, Customer Service, 222 Rosewood Drive, Danvers, MA 01923 USA; +1 978 750 8400. Permission to photocopy portions of any individual standard for educational classroom use can also be obtained through the Copyright Clearance Center.

Updating of IEEE Standards documents

Users of IEEE Standards documents should be aware that these documents may be superseded at any time by the issuance of new editions or may be amended from time to time through the issuance of amendments, corrigenda, or errata. An official IEEE document at any point in time consists of the current edition of the document together with any amendments, corrigenda, or errata then in effect.

Every IEEE standard is subjected to review at least every ten years. When a document is more than ten years old and has not undergone a revision process, it is reasonable to conclude that its contents, although still of some value, do not wholly reflect the present state of the art. Users are cautioned to check to determine that they have the latest edition of any IEEE standard.

In order to determine whether a given document is the current edition and whether it has been amended through the issuance of amendments, corrigenda, or errata, visit the IEEE-SA Website at <http://ieeexplore.ieee.org/xpl/standards.jsp> or contact IEEE at the address listed previously. For more information about the IEEE-SA or IEEE's standards development process, visit the IEEE-SA Website at <http://standards.ieee.org>.

Errata

Errata, if any, for all IEEE standards can be accessed on the IEEE-SA Website at the following URL: <http://standards.ieee.org/findstds/errata/index.html>. Users are encouraged to check this URL for errata periodically.

Patents

Attention is called to the possibility that implementation of this standard may require use of subject matter covered by patent rights. By publication of this standard, no position is taken by the IEEE with respect to the existence or validity of any patent rights in connection therewith. If a patent holder or patent applicant has filed a statement of assurance via an Accepted Letter of Assurance, then the statement is listed on the IEEE-SA Website at <http://standards.ieee.org/about/sasb/patcom/patents.html>. Letters of Assurance may indicate whether the Submitter is willing or unwilling to grant licenses under patent rights without compensation or under reasonable rates, with reasonable terms and conditions that are demonstrably free of any unfair discrimination to applicants desiring to obtain such licenses.

Essential Patent Claims may exist for which a Letter of Assurance has not been received. The IEEE is not responsible for identifying Essential Patent Claims for which a license may be required, for conducting inquiries into the legal validity or scope of Patents Claims, or determining whether any licensing terms or conditions provided in connection with submission of a Letter of Assurance, if any, or in any licensing agreements are reasonable or non-discriminatory. Users of this standard are expressly advised that determination of the validity of any patent rights, and the risk of infringement of such rights, is entirely their own responsibility. Further information may be obtained from the IEEE Standards Association.

Participants

At the time this IEEE recommended practices document was completed, the IEEE P1789 Working Group had the following membership:

Brad Lehman, *Chair*
Michael Poplawski, *Vice Chair*
Howard Wolfman, *Secretary*

Robert Altkorn
David Bannister
Sam Berman
Anindita Bhattacharya
Scott Brown
Xiao Chen
Pei-Ting Chou
Henry S.-H. Chung
Jon Connell
James Dakin
Montu Doshi
Jiri Drapela
Yuan Fu

Zdenko Grajcar
Steve Hayes
Jiao Jianzhong
Faisal Khan
Susan Larson
James Lazar
Peng Li
Yan-Fei Liu
Jonathan McHugh
Naomi Miller
David Neal
Brandon Oakes

Yoshi Ohno
Radu Pitigoi-Aron
Gene Rider
Scott Riesebosch
Anatoly Shteynberg
Michael Shur
David Sliney
Jennifer A. Veitch
Ingrid Vogels
Arnold Wilkins
Peter Wilson
Liang Yan
Regan Zane

The following members of the individual balloting committee voted on this recommended practices document. Balloters may have voted for approval, disapproval, or abstention.

Robert Altkorn
David Bannister
Sam Berman
Bill Brown
Liuchen Chang
Xiao Chen
Henry S.-H. Chung
James Dakin
Sourav Dutta
Randall Groves

Brad Lehman
Peng Li
Yan-Fei Liu
Homer Alan Mantooth
William McBride
Jonathan McHugh
Naomi Miller
Dorin Neacsu
Charles Ngethe
Michael Poplawski
Gene Rider

Bartien Sayogo
Su Sheng
Eugene Stoudenmire
Jennifer A. Veitch
John Vergis
Ingrid Vogels
Arnold Wilkins
Peter Wilson
Howard Wolfman
Liang Yan

When the IEEE-SA Standards Board approved this recommended practices document on 26 March 2015, it had the following membership:

John D. Kulick, *Chair*
Jon Walter Rosdahl, *Vice Chair*
Richard H. Hulett, *Past Chair*
Konstantinos Karachalios, *Secretary*

Masayuki Ariyoshi
Ted Burse
Stephen Dukes
Jean-Philippe Faure
J. Travis Griffith
Gary Hoffman
Michael Janezic

Joseph L. Koepfinger*
David J. Law
Hung Ling
Andrew Myles
T. W. Olsen
Glenn Parsons
Ronald C. Petersen
Annette D. Reilly

Stephen J. Shellhammer
Adrian P. Stephens
Yatin Trivedi
Phillip Winston
Don Wright
Yu Yuan
Daidi Zhong

*Member Emeritus

Michelle Turner
IEEE-SA Content Production and Management

Erin Spiewak
IEEE-SA Technical Program Operations

www.Lisungroup.cc

Introduction

This introduction is not part of IEEE Std 1789-2015, IEEE Recommended Practices for Modulating Current in High-Brightness LEDs for Mitigating Health Risks to Viewers.

The IEEE P1789 Working Group was formed in December 2008. Prior that time, the impact of flicker in light-emitting diode (LED) lighting was not being discussed. New technologies were being developed in LED lamps that introduced high levels of flicker. Occasionally, under special circumstances, some lamps would fail and cause flicker that could introduce seizures in the small percentage of the population that suffers from photosensitive epilepsy. One of the initial reasons to form the working group was to bring together a diverse community of experts to discuss the effects of flicker: members from the medical community, lighting community, photobiologists, electrical engineers, and many more. Without a community discussing the issue of flicker, it would not be possible for developers of LED lighting to fully understand any health effects that might be related to their design. The intent of this document is to explain what is known about flicker in LED lighting and to provide recommended practices that can help mitigate possible adverse biological effects of light flicker, when such mitigation is desired.

This document was written through the following procedure:

- a) Creation of an outline of topics using teleconferences and web board discussions;
- b) Drafting of various publications and other working documents by primary authors;
- c) Presentation and editing of the working documents by subcommittees composed of experts in lighting, health, and flicker;
- d) Approval of the working documents of the subcommittees to be presented to all members of the working group;
- e) Presentation of the working documents to all members of the working group by teleconferences and electronic media;
- f) Solicitation of comments and edits from all members of working group;
- g) Revision of the working documents to include member comments;
- h) Merging of all the working documents into this formal recommended practices document;
- i) Inclusion of additional material into the merged document, written by primary authors and necessary to make the recommended practices more complete;
- j) Obtaining of comments and edits from subcommittees on the recommended practices;
- k) Revision of the recommended practices document according to subcommittee comments;
- l) Submission of the recommended practices document for comments to all members of the working group;
- m) Revision of the recommended practices document according to the comments from working group members; and
- n) Submission of the recommended practices document for ballot, following the official IEEE standards balloting process for approval (not described here).

The IEEE P1789 Working Group effort is an open process. All official comments or proposed edits from working group members for this document were formally entered onto a comment form. Regardless of whether a comment was fully accepted, partially accepted, or rejected, the reasons for the decision were also entered on the form. As a matter of transparency and ethics, only comments submitted through comment forms or in official working group meetings/teleconferences were reviewed by working group members.

The process to develop this document took longer than initially anticipated. While the material in Clause 5 and Clause 6 was developed by the working group carefully and in a timely fashion, the group wanted to carefully weigh all the available scientific data in an objective and fair manner before it developed any recommended practice. It was decided that the working group members should develop a hazard and risk analysis for flicker using a formal process. The development of the material in Clause 7 was led by the same authors that developed the European Union Commission's policy on consumer product recall. That is, the material in Clause 7 was carefully developed over a one- to two-year period by experts in hazard

analysis who accumulated research data and scientific references and flew around the world (at their own expense) to interview experts in flicker, LED lighting, and human vision—all to prepare the material in Clause 7.

Similarly, the philosophy of the working group was to recruit experts in diverse research fields whenever necessary to help develop material. To create a comprehensive and precise set of recommended practices, it was necessary to include in the working group research experts in the fields of power electronic drivers, risk analysis, photobiology, vision, lamp design, psychology, LEDs, and many other areas. The result was a diverse field of experts, able to interpret scientific studies in medical fields, vision, electrical engineering, hazard analysis, and lighting. Many of the authors of the original scientific studies that are discussed in this document also contributed to, and authored text in, this document; this collaboration leads to a strong confidence in the scientific accuracy of IEEE Std 1789.

Each clause was developed by separate subcommittees, and then input and comments were received from the entire IEEE 1789 community about the individual clauses. Brad Lehman, chair, served as editor-in-chief of the entire document, but he also served as editor of Clause 1–Clause 3 and Clause 5 and co-editor of Clause 6 and Clause 8. Jennifer Veitch served as editor of Clause 4. Clause 7 had three co-editors: Bob Altkorn, Xiao Chen, and Gene Rider. Additionally, Arnold Wilkins served as co-editor of Clause 6 and Clause 8. Dozens of IEEE members contributed technically to the document, but major writing contributions of this document were performed by Sam Berman, Faisal Khan, Naomi Miller, and Michael Poplawski in addition to the previously listed editors.

A goal of this working group and recommended practices document is to aid all standards groups that want to develop suitable standards or certification processes about flicker in LED lighting. Observers from various agencies were included in the working group (ENERGY STAR, NEMA, IEC, CIE, OSHA, and many others). The working group plans to continue to work with these agencies and remain a resource for them in their processes (see <http://grouper.ieee.org/groups/1789/>).

www.Lisungroup.com

Contents

1. Overview	1
1.1 Scope	1
1.2 Purpose	1
1.3 How to use this document.....	2
1.4 Context and contents	3
2. Normative references.....	4
3. Definitions, acronyms, and abbreviations	5
3.1 Definitions	5
3.2 Acronyms and abbreviations	5
4. Flicker.....	5
4.1 What is flicker?.....	5
4.2 The need for recommended practices specifically for LED lighting	8
5. Explanation of flicker in LED lighting: Power electronic drivers	10
5.1 LED driving current frequencies in the range of ~100 Hz to 120 Hz	10
5.2 LED driving current frequencies in the range of 3 Hz to 70 Hz	12
5.3 PWM LED driving current frequencies in the range of 120 Hz to ~1 kHz	15
5.4 Experimental measurements of flicker in various light sources	17
6. Biological effects of flicker	20
6.1 Photosensitive epilepsy.....	20
6.2 Invisible flicker.....	22
6.3 Summary of biological effects.....	22
7. Risk assessment.....	24
7.1 Introduction and summary	24
7.2 Methodology.....	30
7.3 Terms used in the risk assessment	31
7.4 Risk assessment of different biological effects of flicker	32
7.5 Conclusion	42
8. Recommended practices	43
8.1 Recommended practices summary	43
8.2 Discussions about exposure duration.....	46
8.3 Justifications for recommended practices	47
8.4 Subharmonics at line frequency.....	52
8.5 Final comments on recommend practice	55
Annex A (informative) Glossary	57
Annex B (informative) Bibliography.....	60

IEEE Recommended Practices for Modulating Current in High-Brightness LEDs for Mitigating Health Risks to Viewers

IMPORTANT NOTICE: IEEE Standards documents are not intended to ensure safety, security, health, or environmental protection, or ensure against interference with or from other devices or networks. Implementers of IEEE Standards documents are responsible for determining and complying with all appropriate safety, security, environmental, health, and interference protection practices and all applicable laws and regulations.

This IEEE document is made available for use subject to important notices and legal disclaimers. These notices and disclaimers appear in all publications containing this document and may be found under the heading “Important Notice” or “Important Notices and Disclaimers Concerning IEEE Documents.” They can also be obtained on request from IEEE or viewed at <http://standards.ieee.org/IPR/disclaimers.html>.

1. Overview

1.1 Scope

The scope of this recommended practices document is to

- Define the concept of modulation frequencies for light-emitting diodes (LEDs) and discuss their applications to LED lighting.
- Describe LED lighting applications in which modulation frequencies pose possible health risks to users.
- Discuss the dimming of LEDs by modulating the frequency of driving currents/voltage.
- Present recommendations for modulation frequencies (flicker) for LED lighting and dimming applications to help protect against known potential adverse health effects.

1.2 Purpose

Presently, there are no standards on safe modulating frequencies for high-brightness LEDs. Vendors suggest various driving frequencies—some at low frequencies and others at high frequencies. In the late 1980s and early 1990s, studies showed that office fluorescent lighting with magnetic ballasts modulating at twice the ac line frequency increased the incidence of health-related problems, such as headaches, eyestrain, and, when the lamps were in failure, epileptic seizures. The detrimental effects depend on factors such as brightness, angle of viewing, wavelength, and depth of modulation, among others. The purpose of this document is to describe some possible health risks associated with low-frequency modulation of

high-brightness LEDs and provide recommended practices to aid the design of LED driving systems to modulate at benign frequencies in order to help protect against the described health risks.

1.3 How to use this document

This document is divided into eight clauses. Clause 1 provides the scope of this guide and its context with respect to other IEEE standards and other standards that are related to the subject of flicker. (Clause 2 is reserved for future normative references.) Clause 3 lists relevant acronyms and abbreviations. Note that no new definitions have been generated for this document; however, for the convenience of the reader, important definitions already in existence are cited in the glossary (Annex A). Clause 4 introduces the concept of flicker and its metrics for lighting applications. Clause 5 describes how the various methods used in the power electronic drivers for LED lights will have different effects on the light flicker that is produced in the LED luminaire. Clause 6 gives a summary of the biological effects of flicker that have appeared in the literature cited in this document (see the bibliography in Annex B). Clause 7 presents formal risk analysis for flicker in LED lighting. Clause 8 presents three recommended practices relating flicker to modulation depth and frequency. It should be mentioned that operating outside the low-risk recommended practice regions presented in Clause 8 does not necessarily imply high risk. However, following the recommended practices would lead to high confidence that there is low risk of health problems to viewers due to flicker. This issue is further discussed in Clause 8.

This document also contains two annexes. Annex A presents basic definitions used in vision and lighting with which a typical power electronics designer may not be familiar. Annex B is a bibliography of materials cited in this document.

This document attempts to provide information to the reader (e.g., ballast designers, other standards, or certification organizations), using the best knowledge available at the present time, on how to help mitigate the risk of distractions and possible adverse biological effects caused by flicker in LED lighting. At minimum, designers may decide to use this information to help design the output filters or switching frequency of their driving methods for LED lamps. The authors of this document recognize, also, for example, that it is common in the video game industry to put warning labels in their products/manuals to alert photosensitive people about their products if they believe flicker is a concern. Without the information in this document, designers could be unaware of how their lighting design decisions may impact human biological responses. This document should therefore be a valuable informational resource to the entire lighting industry, LED IC driver manufacturers, LED manufacturers, and even to the broader designers of luminaires other than LEDs (since much of what is described in this document is applicable to all types of lighting).

As the use of LED lighting proliferates in the consumer sector, it is vital for the lighting design community and other standards organizations to determine how to best use the information in this document. The recommended practices presented in Clause 8 describe how to help mitigate the risk of possible adverse biological effects of LED lighting. They may be, at times, conservative for specific lighting applications. This issue is thoroughly and openly discussed in Clause 8. However, following the guidelines presented should lead to minimal biological effects of the flicker in the LED luminaires. The recommended practices represent recommended low-risk operating regions of flicker. Operating outside these recommended low-risk regions does not necessarily imply high risk, however. Instead, the purpose of the recommended practices is to present potentially lower risk regions that, for many LED driver approaches, are not difficult to achieve.

One of the strengths of this document is that Clause 7 adapts a rigorous risk assessment framework formally used by government agencies and consumer protection agencies for product safety evaluation. This risk assessment follows the method developed by the Eurosafe Working Group on Risk Assessment (Rider et al. [B90]) and is similar in form to the SCENIHR “Scientific opinion on light sensitivity” [B95].¹ This formal analysis procedure is able to separate the discussions on severity of the biological effect,

¹ Numbers in brackets correspond to the numbers in the bibliography in Annex B.

probability of occurrence, and confidence level of the scientific data on which the conclusions are based. This approach was adopted so that areas that have limited experimental data can be discussed openly within the lighting community. In fact, an additional purpose of this document is to urge industry and research laboratories to continue to critically evaluate data from research and from field experience and make additional recommendations when supported by data. The risk analysis discussion in Clause 7 should allow research entities to identify areas of valuable research topics that could further the understanding of the human biological effects of light flicker.

The purpose of this subclause is to assist the reader in applying the recommendations of this document to particular cases of interest in LED lighting. LEDs as a light source do not inherently flicker. Nevertheless, when coupled with their driving electronics, some (but not all) LED lighting products will exhibit more pronounced flicker than current fluorescent and incandescent lamps, even as high as high-pressure sodium (HPS) lamps. This study was undertaken to collect what is known about potential undesirable health effects of flicker—especially urgent because government and industry studies project that LED lighting products will account for as much as 50% of the lighting market by the year 2020.

It is important to mention that, when determining the most suitable light source for a specific application, flicker is only one condition that must be considered, along with factors such as luminous intensity and color metrics, power factor, electromagnetic fields of the driver circuitry, audio noise of chokes, total harmonic distortion metrics, reliability and life metrics, energy saving, cost, lighting application, etc. The scope of this document, though, is to emphasize flicker performance. It is beyond the scope of IEEE Std 1789 to explain many of these other design aspects, but they may also be important in making lighting decisions.

This document provides recommended practices that can help mitigate the risk of possible adverse biological effects of flicker in LED lighting. The recommended practices are suitable for all LED lighting in general illumination. In other words, this document does not separate the discussion into different lighting applications and then create recommended practices for each of the lighting application circumstances. The reasons for this approach are extensively discussed in Clause 7 and Clause 8. However, it could be the next step for other organizations to develop lighting-application-specific recommended practices. This may be within the scope of other certification and standards groups, such as CIE, IEA 4E Solid State Lighting group, ISO TC 274, ENERGY STAR, CALiPER, etc. A logical next step would be for these bodies to use this IEEE document to help develop particular standards that may include lighting-specific applications, weighing such matters as adaptation luminance, color, tasks, etc. The end of Clause 8 further clarifies this idea and urges the lighting community to continue to expand guidelines for flicker in LED lighting.

1.4 Context and contents

This recommended practices document is divided into seven subsequent clauses.

- Clause 2 (the clause traditionally reserved by IEEE to list other standards that are integral to implementing the IEEE document) is included only to point out that no other standards are necessary to implement this document.
- Clause 3 (the clause traditionally reserved by IEEE to define relevant terms) is included only to point out that no new definitions have been created for this document. For the convenience of the reader, some existing definitions are provided in the glossary (see Annex A) and Clause 4, and other definitions can be found in the *IEEE Standards Dictionary Online*.
- Clause 4 describes and presents the need for creating recommended practices pertaining to flicker.
- Clause 5 explains how flicker is introduced when utilizing power electronic drivers for LED lighting. The material is divided into four subsections:
 - LED driving methods, which typically produce flicker at twice the ac power line frequency, are discussed. Only a brief introduction is presented, and the methods are sometimes simplified so that the basic concepts of the driving approaches can be understood.

- Failure modes for LED driving methods that may cause flicker to have frequency between 3 Hz and 70 Hz are presented. This frequency range is of particular concern because it may cause seizures in people that are susceptible to photosensitive epilepsy.
- The topic of dimming is presented, and its relation to flicker frequency is discussed.
- Various experimental waveforms of flickering light sources are presented.
- Clause 6 presents an overview of the various reported biological effects of light flicker.
- Clause 7 gives a formal risk assessment of flicker in LED lighting. For the major enumerated potential health risks, the clause covers epidemiology, severity, susceptible subgroups, and values of influential parameters. A discussion of Low-Risk Levels based on the evaluated risk analysis parameters is introduced to provide background to the recommended practices presented in Clause 8. Clause 7 presents the following material:
 - A brief introduction to this risk assessment presents the assumptions and then illustrates the risk assessment results in figures.
 - The methodology of the risk assessment strategy is presented. It follows the method developed by the Eurosafe Working Group on Risk Assessment (Rider et al. [B90]) and is similar in form to the SCENIHR “Scientific opinion on light sensitivity” [B95]. A strength of this approach is that it categorizes confidence levels of the data used in the analysis.
 - The probability levels and severity levels used in the risk assessment are explained.
 - Risk assessment of different possible biological effects of flicker is presented. The topics discussed include photosensitive seizure, stroboscopic effect, migraine, aggravation of autistic behaviors, performance asthenopia/eyestrain, and headaches as well as a mention of anxiety and vertigo-related issues. The hazard level, probability of occurrence, and confidence level of the research are discussed for the different biological effects.
- Clause 8 presents the recommended practices. The recommended practices give guidelines on the relation between flicker frequency and modulation percentage that can be maintained in order to help mitigate the risk of possible biological effects of flicker. Clause 8 is divided as follows:
 - Three recommended practices are presented, and then examples are given on how the recommended practices may be applied.
 - Justification about deriving a recommended practice for general lighting applications instead of separate recommended practices for different lighting applications is presented.
 - A more in-depth justification of the derivation of the recommended practices is given. The recommended practices are validated by multiple independent research studies as well as small-scale real-world lighting applications. The conservativeness of the recommended practices is discussed.
 - The issue of subharmonics is presented. The recommended practices have made the assumption that there is no power line flicker and that the flicker in the LED lamps is produced due to the driving method only. It is possible that this assumption is not the case and a method is proposed, but is not part of any recommended practice, which may be used to adapt a recommended practice to the case of subharmonic flicker.
 - Final comments are given.
- Annex A gives basic definitions used in vision and lighting with which a typical power electronics designer may not be familiar.
- Annex B is a bibliography of materials cited in this document.

2. Normative references

There are no other documents that are indispensable for the application of the recommended practices outlined in this document.

NOTE 1—Related IEEE documents are referred to in the text and are helpful to understand the voltage flicker issue for incandescent bulbs. These documents explain how power line harmonics influence incandescent flicker, and Clause 8 utilizes these documents (and other scientific documents) to help validate the recommended practices (see IEC 61000-3-3:2013 [B56] and IEC 61000-4-15:2010 [B57]).²

² Notes in text, tables, and figures are given for information only and do not contain requirements needed to implement the standard.

NOTE 2—Peripherally related lighting standards exist. In Europe, high-brightness LEDs are often held to similar optical standards as Class 1 lasers, EN60825, but this practice has not been the case for the United States. These standards for lasers are concerned primarily with optical radiation. Furthermore, documents exist for best working practices for indoor lighting, but do not cover health effects of flicker (see ANSI/IES RP-1-04 [B1], ISO/CIE 8995-1:2002 [B60], IEC 62471:2006 [B58], and IEC 60825-1:2007 [B55]).

3. Definitions, acronyms, and abbreviations

3.1 Definitions

The *IEEE Standards Dictionary Online* should be consulted for terms not defined in this clause. No new definitions have been generated while developing this document. However, for the convenience of the reader and for tutorial purposes, Annex A presents some basic definitions in the fields of lighting science. Clause 4 also introduces some basic definitions on flicker as well as their associated metrics.³

3.2 Acronyms and abbreviations

CFF	critical flicker fusion frequency
CFL	compact fluorescent lamp
EEG	electroencephalograph or electroencephalogram
f	frequency
HID	high-intensity discharge
HPS	high-pressure sodium
LED	light-emitting diode
MH	metal halide
$Mod\%$	Modulation (%)
LPS	low-pressure sodium
NOEL	no observable effect level
PFC	power factor correction
PWM	pulse width modulation or modulated
rms	root-mean-square
SSL	solid-state lighting

4. Flicker

4.1 What is flicker?

Light modulation has many names, including flicker, flutter, and shimmer. The Illuminating Engineering Society's (IES) *Lighting Handbook* [B28] defines *flicker*—the most commonly used term—as “variations of luminance in time” (see also CIE S 017/E:2011 [B21]).⁴ Here, IEEE Std 1789 is concerned with flicker

³ *IEEE Standards Dictionary Online* subscription is available at:

http://www.ieee.org/portal/innovate/products/standard/standards_dictionary.html.

⁴ Photometric flicker should not be confused with electrical flicker, which refers to noise on ac distribution lines that can directly create additional (light) modulation on resistive (incandescent) loads. In cases of electrical flicker, the ac line is the source of the modulation, rather than characteristics of the light source design and construction.

as a characteristic of the light source design and construction. (See Annex A for formal definitions of flicker.)

All light sources modulate light, or flicker, to some degree, usually as a consequence of their drawing power from ac mains sources (i.e., 60 Hz ac in North America). The flicker created by electrically powered light sources is typically periodic. A periodic waveform can be characterized by at least four parameters: its amplitude modulation (i.e., a variation in amplitude over a periodic cycle), its average value over a periodic cycle (also called the *dc component*), its shape or duty cycle (in this recommended practices document, *duty cycle* normally refers to the percentage of time spent at maximum value in pulse width modulated (PWM) square waves), and its periodic frequency. The viewer's response to a flickering light depends on all these characteristics; of these, frequency has been the most studied and is better understood.

Throughout this document, reference is made to variation in light intensity associated with flickering light. Several metrics have been developed and used to quantify this intensity variation. These existing metrics are defined below. Where documentation exists, the specific metric used in cited studies is noted.

- Flicker index, introduced by Eastman and Campbell [B30], is defined by Lehman et al. [B72] as the area above the line of average light divided by the total area of the light output curve for a single cycle. Referring to Figure 1,

$$\text{Flicker Index} = (\text{Area 1}) / (\text{Area 1} + \text{Area 2})$$

- Percent flicker, also known as peak-to-peak contrast, Michelson contrast, Modulation (%), or modulation depth (Lehman et al. [B72]). Referring to Figure 1, percent flicker is defined as

$$\text{Percent Flicker or equivalently Modulation (\%)} \\ \text{Mod\%} = 100 (\text{Max} - \text{Min}) / (\text{Max} + \text{Min}) = 100 (A - B) / (A + B)$$

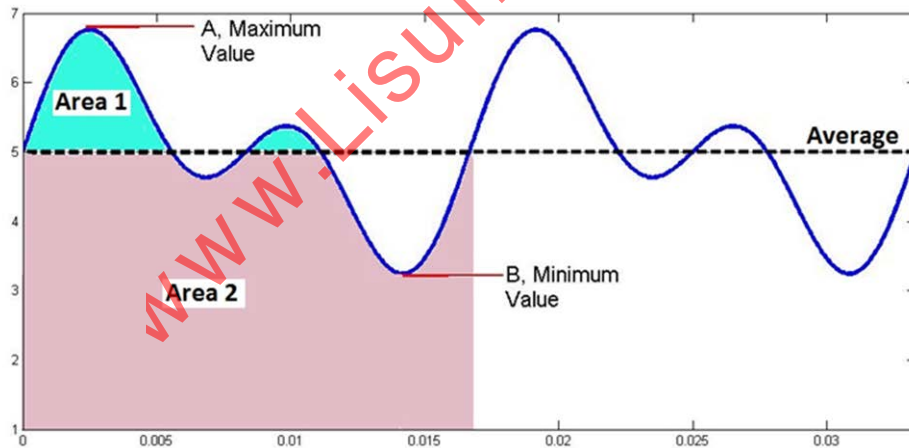

Figure 1—Diagram for definition of flicker index and percent flicker

For example, flicker exists in most light sources, but with varying levels. This is true for the different types of lighting technologies such as incandescent, fluorescent, and solid-state lighting (SSL). In particular, SSL flicker is dependent on the method that is used to convert the input electric signal from a typical ac input to the desired dc output that the LEDs utilize. This is further explained in Clause 5.

Flicker refers to the modulation of luminous intensity in a lamp. However, Clause 5 refers to the modulation of LED current through the lamp. The assumption is that LED current is approximately proportional to the luminous flux output of the LED. Therefore, reference to LED current is meant to infer

reference to LED luminous intensity and vice versa. (Thus no consideration is being given to operating the LED in its nonlinear saturation regions above rated currents.) This implies, for example, that a Modulation (%) of 100% in flicker is equivalent to a Modulation (%) of 100% in LED current.

In LED power electronic drivers, typical design specifications in application notes might include specifications on peak-to-peak LED ripple current% or root-mean-square (rms) LED ripple current. Peak-to-peak LED current% = $100 \times (ILED_{max} - ILED_{min})/ILED_{avg}$, where $ILED$ represents the current through the LED. For the special symmetric cases when $ILED_{avg} = 0.5 \times (ILED_{max} + ILED_{min})$, then the peak-to-peak LED ripple current% is equal to twice the Modulation (%). This may be typical of triangular wave periodic flicker or sinusoidal wave flicker in LED currents that are commonly produced in LED drivers. Relating rms of the ripple current to Modulation (%), however, is more complicated. This depends on the shape of the LED current, even if it is symmetric.

Examples of flicker in lighting can be seen in Figure 2 for incandescent bulbs and in Figure 3 for LED lighting. The luminous flux is normalized on the vertical axis so that the maximum value equals 1. Therefore, the percent flicker simplifies to $100 \times (1 - Min)/(1 + Min)$, where the minimum value is specified in each figure. Figure 2 and Figure 3 represent only sample flickering outputs in luminaires. Extensive testing and measurements of flicker in LED and other lamps can be found in Lehman et al. [B72] and in several U.S. Department of Energy (DOE) and Pacific Northwest National Laboratory (PNNL) publications (Poplawski et al. [B84], Poplawski and Miller [B83], Poplawski [B85], and Miller et al. [B77]).

For the human observer, flicker can be broken into categories, based on detection (sensation) and perception (Wilkins et al. [B117]) (see Annex A for more precise definitions).

- Sensation: The eye/brain/neurological system detects the modulation of light output over time in the external conditions, and neurons respond.
- Visible flicker: The luminous modulation is sensed and consciously perceived.
- Invisible flicker: The luminous modulation is sensed, but not consciously perceived (unless it is appreciated in terms of effects on spatial perception, such as the phantom array or the stroboscopic effect).

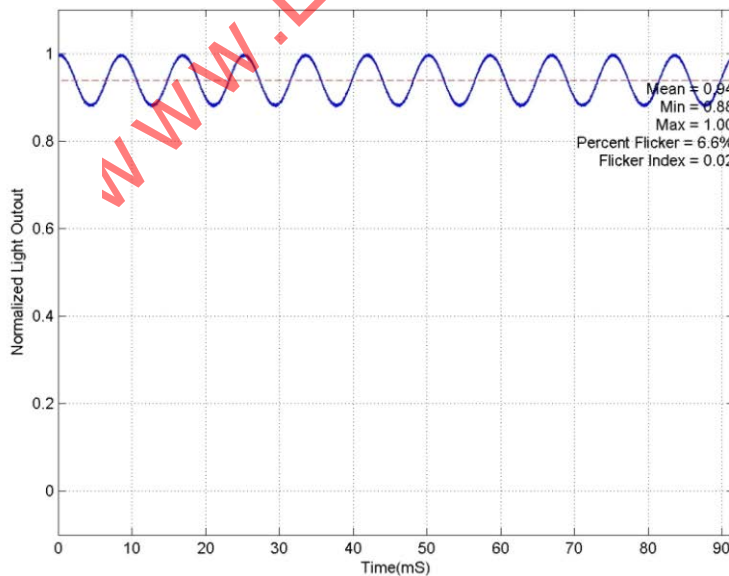

Figure 2—Typical incandescent lamp flicker of ~6.6% (Lehman et al. [B71])

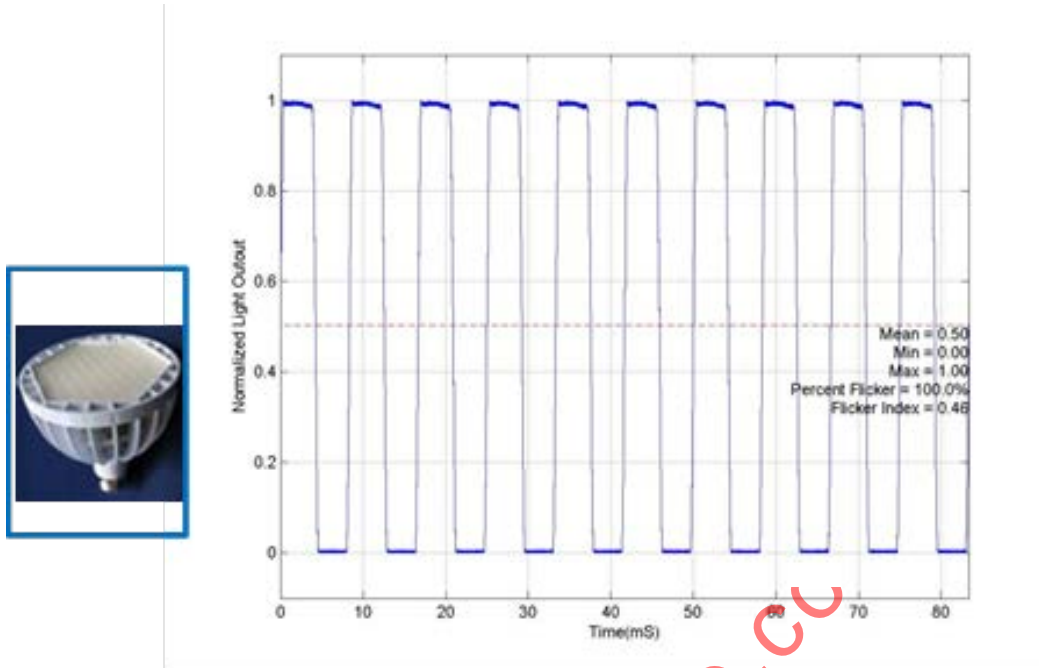

Figure 3—Example SSL flicker at 100% (Lehman et al. [B71])

For most people, flicker that occurs with a frequency of less than 60 Hz is visible. The frequency at which a flickering light source fuses into an apparently constant source varies for individuals and depends on the modulation amplitude, adaptation luminance, and visual field size of the source. However, this critical flicker fusion frequency (CFF) occurs generally in the range of 60 Hz to 100 Hz (Kelly [B65]). Invisible flicker, occurring at a rate greater than the CFF, may nonetheless have physiological effects even though the individual normally cannot report the conscious perception of flicker (see Clause 6).

Flicker was an issue when magnetically ballasted fluorescent lamps were common, before the mid-1990s. Research at that time identified flicker of the light source to be related to migraines, headaches, reduced visual performance and comfort, and other possible neurological health issues (see Clause 7). When high-frequency electronic ballasts were introduced for energy efficiency, the negative effects of flicker were reported less frequently and largely disappeared from public discourse. In the meantime, magnetically ballasted high-intensity discharge (HID) lamps have been continuously used for outdoor light with relatively few complaints despite their high modulation depth.

With the introduction of SSL products to the marketplace, flicker has re-emerged as a consideration, partly because the modulation of light-emitting diode (DOE [B106]) light output has been frequently observed to be greater than the modulation seen with fluorescent or HID sources (Poplawski et al. [B84]). For LED sources, flicker is primarily determined by the driver. Some driver designs produce little to no detectable flicker at full or dimmed outputs; others flicker noticeably at both full and dimmed output; still others produce little to no flicker at full output, but flicker objectionably when dimmed. Some LED products produce flutter or light level instabilities while the dimming level changes from one level to another. The flutter or light level instabilities disappear when the dimming level remains constant.

4.2 The need for recommended practices specifically for LED lighting

SSL is widely recognized as revolutionary, and the technology offers the promise of dramatically reducing lighting energy use. Reports produced for the DOE project that the adoption of LEDs for general lighting could result in savings on the order of 19% less electricity used for lighting by 2020, and 46% by 2030 (DOE [B106]). Such a reduction would deliver substantial savings for building owners and operators

(including households) and has the potential to deliver important societal benefits in the form of reduced greenhouse gas emissions and the release of electrical generating capacity for other uses.

These projected energy savings are based on assumptions about the adoption of this new technology; if these assumptions are not met, the savings will not occur. The path to adoption of any new technology should take into account lessons learned from the introduction of previous technologies. In the case of LED lighting, the comparator case is the introduction of compact fluorescent lamps (CFLs) in the early- to mid-1990s. It is widely accepted that the uptake of CFLs was much slower than had been anticipated, and the projected energy savings did not materialize (Sandahl et al. [B94]). Equipment performance was among the problems that hindered adoption, and one of the key lessons derived from the CFL experience was “Don’t launch a product until performance issues are ironed out” (Sandahl et al. [B94]).

Among the performance issues that contributed to slow CFL uptake was the perception that fluorescent lighting can cause adverse health effects. Flicker had long been among the complaints made about fluorescent lighting (Stone [B103]), when Beckstead and Boyce [B4] found that the belief that fluorescent lighting could cause negative effects on people predicted the likelihood that people would use fluorescent lighting at home. As the lighting industry strives not to repeat the CFL experience, these findings underpin the need for recommended practices concerning LED flicker.

Other clauses of this document summarize what is known concerning the effects of flicker on human health and well-being (see Clause 6) and the variety of flicker rates that LED lighting systems can exhibit (see Clause 5). Possible adverse health effects can occur under flicker conditions that lie outside the visible range (see Clause 7); the nervous system can detect and respond to these conditions without their being accessible to conscious reports of the perception. This sets the stage for learned associations between LED lighting and potential adverse health effects from the specific product to the general class of LED products.

Given the wide variety of flicker patterns detected in LED products already on the market (Poplawski et al. [B84]), some of which may lie in the region where potential health risks exist, it is possible that the public will associate this new technology with negative health outcomes. However, the lighting industry has the opportunity through product design to reduce the occurrence of flicker conditions that could cause potential adverse health and well-being effects and thereby help avoid a future in which the public associates LEDs with these outcomes. A recommended practice for LED lighting flicker can make a valuable contribution to the speedy adoption of LED technology and the achievement of energy efficiency targets by defining, based on science and consensus, the flicker conditions that may best be avoided.

Prior to the IEEE P1789 Working Group, there were no formal entities that were allowing designers, health experts, and engineers to discuss the best guidelines flicker in SSL. This vacuum left engineers to design their power electronic drivers without knowledge of possible health effects to the public. The scope of this document is to

- Define the concept of modulation frequencies for LEDs and give discussion on their applications to LED lighting.
- Describe LED lighting applications in which modulation frequencies pose possible health risks to users.
- Discuss the concept of dimming of LEDs by modulating the frequency of driving currents/voltage.
- Present recommendations and design guidelines that can help enable a designer to select, with more knowledge, appropriate power electronic drivers to desirably modulate frequencies for LED lighting and dimming applications to help protect against possible adverse health effects.

At minimum, this document can help educate the community about the need to create desirable LED lighting to help reduce flicker conditions.

5. Explanation of flicker in LED lighting: Power electronic drivers⁵

Several common methods used to drive LEDs can operate with frequency of modulation in the areas of discussion in this recommended practices document, ranging from 3 Hz to ~1 kHz. Some produce visible flicker that may be of concern, while others do not. For example, commercially available LED lamps have been reported (Rand et al. [B86]) to malfunction and produce visual flicker in the 15 Hz range when connected to a conventional residential dimmer.

Below, only a few driving approaches that modulate in various frequency ranges are presented. The list is not exhaustive, and the discussions are meant only to demonstrate typical driving LED currents with frequencies in this range. In this clause, it is helpful to make the following assumptions:

- a) The flicker described below is self-generated/device-inherent flicker. There is no power line flicker, and the flicker in the LED lamps is produced due to the driving method only.
- b) Only a few sample methods of LED driving are considered. Many variations of the presented methods and several other driving approaches that produce flicker are not presented.
- c) Flicker refers to the modulation of luminous intensity in a lamp (see Clause 4). However, this clause refers to the modulation of LED current through the lamp. The assumption is that LED current is approximately proportional to the luminous flux output of the LED.

5.1 LED driving current frequencies in the range of ~100 Hz to 120 Hz

LED driving current frequencies in range are described as follows:

- a) Full-wave rectifier connected to LED string.

In this approach, the ac input source is sent into a full-wave rectifier, causing the (approximate) absolute value of the input voltage to be sent to the load. In this case, the current through the LEDs has a waveform shape similar to a scaled absolute value of a sine wave. That is, the rectified sine wave may be approximately equal $|V_p \sin(\omega t)|$, where V_p is the amplitude of the sine wave and ω is the angular frequency in radians $\omega = 2\pi f$. In this case, the LED current is of similar shape, as Figure 4 shows. In a first approximation, the LED current is equal to a scaled rectified voltage, with the additional dead time (zero current) caused by the LED bias voltage. Thus, when properly functioning, the direct full-wave rectifier driving approach modulates the LEDs at twice the line frequency; this result in North America leads to 120 Hz modulation and in Europe leads to 100 Hz modulation. As Figure 4(a) shows, often a resistor is added in series with the LED string for current limiting protection.

- b) Directly driving two parallel LED strings with opposite anode/cathode connections.

A second LED driving method that doubles line frequency is shown in Figure 4(b). Two strings of LEDs are powered in parallel, with anode of one paralleled string connected to the cathode of the other parallel string. When the ac line voltage is positive, energy drives one of the LED strings. When the ac line voltage is negative, the other paralleled LED string is driven. At most, one of the LED strings has current through it. The net effect is that the effective LED driving current is modulating at 120 Hz in North America or 100 Hz in Europe.

Thus, for both driving methods illustrated in Figure 4, the LED current modulates at twice the line frequency. Since the intensity of the LEDs is (ideally) proportional to the current through the LEDs, this causes the LEDs to flicker at frequency equal to twice the ac line frequency, i.e., 100 Hz to ~120 Hz. Many variations of the approach in Figure 4 are not shown here. The more

⁵ Material in this clause, especially 5.1, 5.2, and 5.3 (including Figure 4, Figure 7, and Figure 8), is taken from Wilkins et al. [B117].

modern approaches generally reduce flicker and harmonic distortion (Shteynberg et al. [B99], Noge and Itoh [B79], and Texas Instruments [B105]).

(a) Rectify ac mains and send to LED string

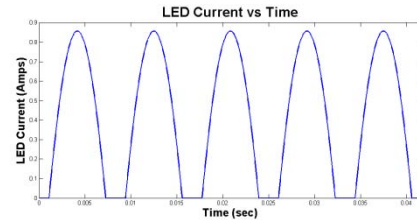
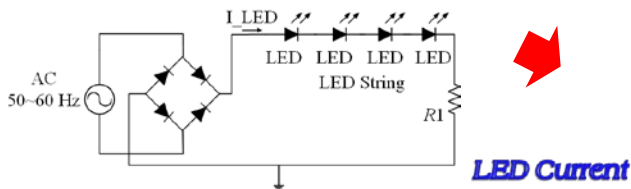

(b) Directly power two LED strings with opposite Anode/Cathode connections

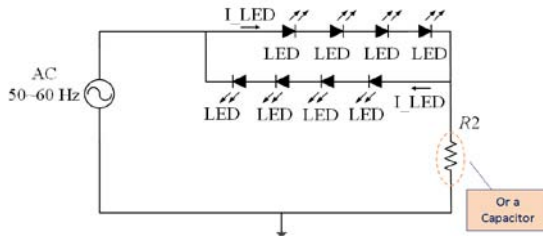

(c) Simulation of current through HB LEDs. Luminous intensity is proportional to current, causing lamp to flicker at twice the line frequency (shown periodically every 1/120 sec)

Figure 4—Two methods to drive LEDs at twice line frequency:
(a) Full bridge rectification and (b) Opposite connection parallel strings
with (c) Current/Luminous output in the LEDs for both approaches
(Lehman and Wilkins [B73])

c) Simple dimming pulse width modulated (PWM) circuits.

It is common to dim LEDs by pulsing the current through them intentionally. The luminous intensity of the LED can be adjusted by varying the length of time that the LED current is High or Low. Thus, PWM dimming circuits may be designed to operate at any frequency, whether the input is dc or ac. (It should be noted that it is not uncommon for LED drivers using ac residential phase modulated dimmer circuits to attempt to “emulate” PWM type signals with frequency 120 Hz. That is, when the ac dimmer shuts off, no current is sent to the LEDs.) Figure 5 illustrates two methods to create PWM current through LEDs. In Figure 5(a) the switch is in series so that when it is ON, the current will flow through the LED. When the switch is off, no current flows through the LEDs. In Figure 5(b), the current flows through the LEDs when the switch is off, while there is no current in the LED when the switch is ON. In either case, the LED current looks similar to Figure 5(c) and has flicker frequency $f = 1/T$, where T is the period of the signal.

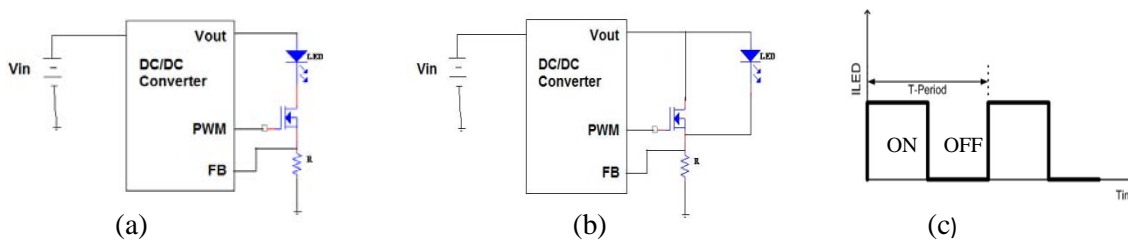

Figure 5—Sending PWM current through LEDs:
(a) Series PWM dimming and (b) Parallel PWM dimming
with (c) PWM current through the LED in either method (Wilkins et al. [B117])

It should be mentioned that there are alternative approaches to dimming, such as amplitude dimming, in which the current through the LED is continuous and not pulsing. By reducing the

value of this continuous current (amplitude), the luminance is dimmed. This approach does not use PWM to adjust luminance; therefore, flickering does not exist, and flicker-related health effects should not be induced.

d) Power factor correction (PFC) circuitry.

Even when sophisticated high-frequency switching power supplies with PFC circuits are used to drive LEDs from ac mains, such as in Figure 6, there is commonly a frequency component in the current (and luminous intensity) of the LEDs at twice the line frequency. Depending on the design of the circuitry, the harmonic content of this flicker may vary from being small and unnoticeable to being significant in magnitude. The modulation depth of the flicker depends on controller design, circuitry being used, and filter component values, among other factors.

Figure 6 shows typical circuitry that may be used in driving the LEDs in a bulb. A two-stage approach (Chen et al. [B18], Arias et al. [B2], Zhang et al. [B121], and Gu et al. [B41]) is illustrated because this can have reduced flicker Modulation (%). A first stage may be used to achieve PFC to meet typical requirements, such as *power factor* > 0.7 given by ENERGY STAR requirements [B31]. The second stage can be used to reduce the percent flicker. On the other hand, some vendors may utilize only a single stage ac-dc approach and keep only the PFC portion of Figure 6 (see Hu et al. [B54], Xie et al. [B119], Chou et al. [B20], and Cheng et al. [B19]). In this case, it is likely that the percent flicker may significantly increase, but there is a benefit of lower cost from lower parts count. Finally, it should be mentioned that linear regulators may be inserted in series with the LEDs to regulate constant dc current so no flicker appears (Hu and Jovanovic [B53]). This comes at the disadvantage of additional power loss.

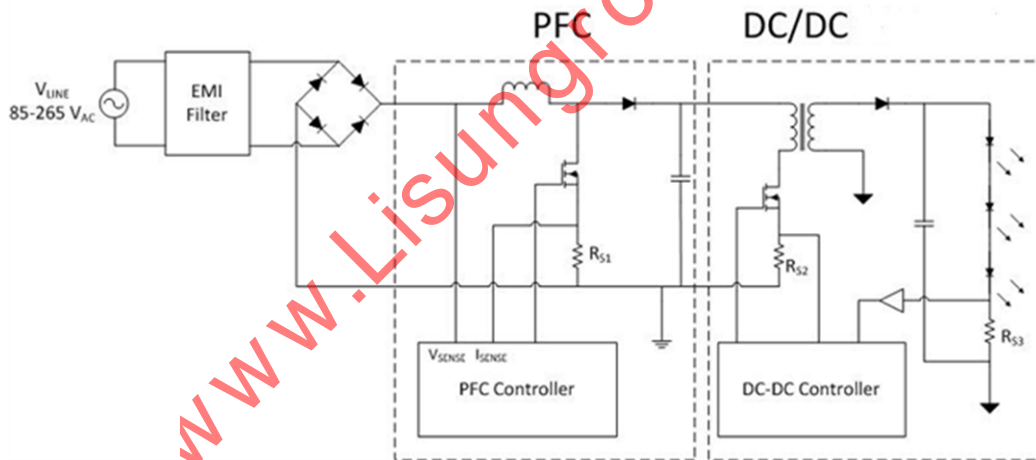

**Figure 6—Typical active PFC circuitry:
some flicker frequency at twice the ac line frequency may remain
(Lehman and Wilkins [B73])**

5.2 LED driving current frequencies in the range of 3 Hz to 70 Hz

LED driving current frequencies in range are described as follows:

a) Failures in rectification or LED strings: 50 Hz to ~60 Hz modulation.

In either of the two methods of Figure 4, there is risk of failure that can cause LED current modulation at ac line frequency, thereby entering the range of frequencies that may induce photosensitive epilepsy that is discussed in Clause 6 and Clause 7. For example, if one of the legs of the full-wave rectifier bridge fails, then it is common that the leg becomes an open circuit. Open

circuits prevent current flow; therefore, the LED modulation frequency may change. This single diode failure in the rectifier will cause the output voltage for the full-wave rectifier to become the input voltage for half the ac line cycle and then 0 V for the remaining half line cycle. In other words, if the ac mains line frequency is f and the period is $T = 1/f$, then nonzero voltage is applied to the LEDs for $0.5 \times T$ seconds and then is zero for the next $0.5 \times T$ seconds; this sequence causes the LED current to modulate at line frequency. In fact, failure of a leg in a full bridge driver will likely cause ac line cycle frequency in any driving method, but the difference with the approach in Figure 4 is that its flicker will occur at $Mod\% = 100\%$.

Similarly, when the two strings of LEDs are connected in parallel with opposite anodes and cathodes in each string, a failure in one string of the LEDs may cause an open circuit to occur in that string. The net effect is the same as before: the current has Modulation (%) with $Mod\% = 100\%$ at line frequency, i.e., 50 Hz to ~ 60 Hz. This low-frequency driving current leads to luminance flicker in the LEDs at 50 Hz to ~ 60 Hz because the current in the LEDs is proportional to their intensity. This is in a range of frequencies that are at risk of causing photosensitive epilepsy.

- b) Residential dimmer switches causing low-frequency flicker (~ 3 Hz to 70 Hz).

Residential dimmers for incandescent bulbs primarily utilize phase modulating dimming through triac switches to control the power sent to the bulb. These dimmers control the rms voltage applied to the bulb by suppressing part of the ac line voltage using a triac. The effect is a chopped sine wave as shown in Figure 7. Thus, as the dimmer switch is manually adjusted, the value of the off-time, α (often referred to as the phase delay), changes. As α is increased in Figure 7, less power goes to the incandescent bulb, and brightness is reduced.

Some LED lamps and their associated drivers may not perform properly with residential phase modulated dimmers. Often on the LED bulb application notes or on the lamp's manufacturer web sites, there are warnings to the user that their bulbs may not work properly when used with residential dimmer switches. Rand et al.'s work [B86] explains the causes of these failures and shows that low-frequency flicker may occur.

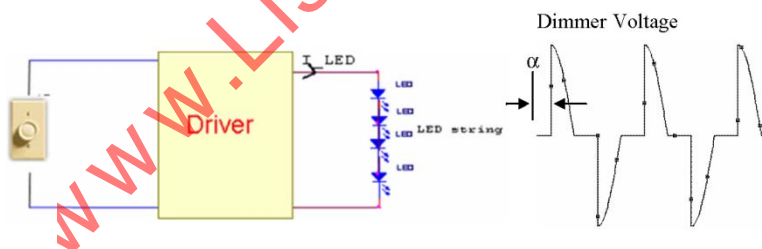

**Figure 7—Residential dimmer and its output voltage
(Rand et al. [B86])**

Figure 8 illustrates how one type of commercially available LED lamp flickers in the noticeable visual range when connected to a dimmer switch. The particular lamp involved has a common LED driver configuration (further discussed below) of a full bridge rectifier with capacitor filter within their Edison socket, described in more detail by Rand et al. [B86]. The results presented in the figure may be typical of similar driving configurations. The circuit will continuously peak charge the filter capacitor to the peak voltage of the input waveform, i.e., 169 V dc for standard 120 V ac line voltage. This high-level dc voltage may then be fed into a large string of LEDs in series. For example, some typical lamps may have parallel strings of many red, blue, green LEDs, in series attached through a current-limiting resistor to the high-level dc voltage. The particular lamp tested utilized a combination of 64 red, green, and blue LEDs to produce white light.

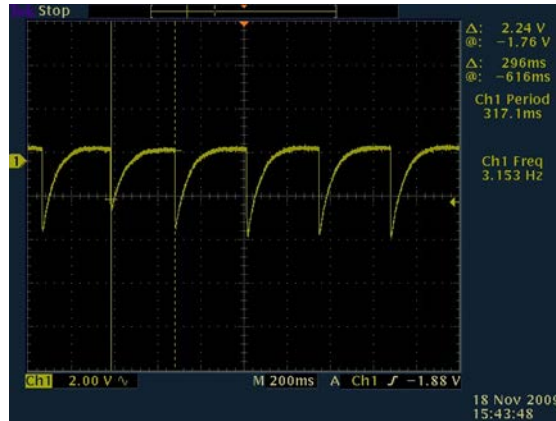

Figure 8—Flicker (at 3.15 Hz) of commercial LED lamp when connected to typical residential dimmer switch (Wilkins et al. [B117])

The experimental data in Figure 8 represent the voltage of a photosensor placed directly underneath the LED lamp. Specifically, a photoresistor circuit is used to generate a voltage proportional to the light intensity shining on it. As the experimental voltage shows, the bulb malfunctions when connected to a (phase-modulated) residential dimmer switch. It produces a noticeable visual flicker. In particular, the flicker varies between around 3.0 Hz and 3.3 Hz, with an average over many cycles of 3.153 Hz. This frequency is in the range that has been shown to be a risk for causing photosensitive epileptic seizures.

The flicker illustrated in Figure 8 is typical of *a few* LED lamps on the market when connected to a dimmer. However, the precise flicker frequency is hard to predict, as it may be either higher or lower depending on various factors such as number of lamps on the dimmer, position of the dimmer switch (the value of desired phase delay α), and/or internal characteristics of the lamp. The problem is compounded by the existence of many different legacy dimmer circuits in the field. However, as the experimental oscilloscope plot shows, the flicker frequency may be in the range that induces photosensitive seizures.

The reasons that the dimmer switch may fail when connected to LED lamp bulbs are given in Rand et al. [B86].

- c) Uneven luminance in different LED strings when connected as in Figure 4(b) with strings having opposite anode/cathode connections.

Consider the circuit in Figure 4(b). Notice that each LED must have the same dynamic characteristics (forward voltage and dynamic resistance) in order for the current to be perfectly balanced in each alternating illuminated string. If for some reason this does not occur (aging, temperature gradients, poor design), then the current through the strings will not be identical each cycle.

For example, suppose over time, aging causes degradation of one of the two strings in Figure 4(b) so that its string resistance increases by 50%. This could also be caused by improper design of each string in Figure 4(b) so that the current in each string is not balanced. This is quite possible because LEDs are binned by different voltages and, furthermore, each string may be composed of different color LEDs that have different nominal voltage drops for the same current. Then, the effective LED current through the bulb will look as in Figure 9.

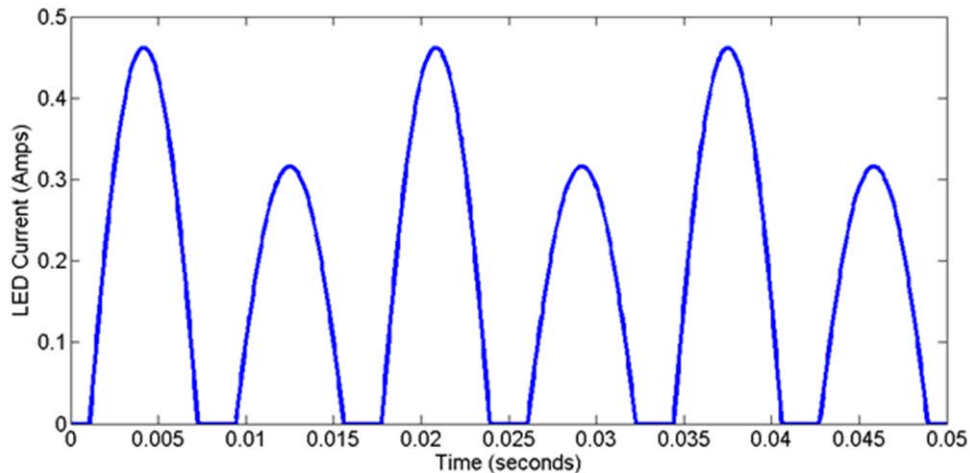

NOTE—The unbalance driving will cause uneven luminous output in the lamp and low-frequency flicker.

Figure 9—Unbalanced LED current in each string of LEDs using driving method in Figure 4(b)

For example, the effective dc LED current in the numerical simulation of Figure 9 has an average value of around 233 mA. However, the Fourier component at 60 Hz (taking Fast Fourier Transform) is 80 mA and the Fourier component at 120 Hz is nearly 240 mA. Thus, in this example, the low-frequency component of 60 Hz represents over 33% of the dc component, while the 120 Hz component represents 100% of the dc current. Higher frequency components of the LED current in the above figure are also present in multiples of 60 Hz. However, the typical analysis above indicates that LED lamps may demonstrate flicker frequency at line frequency, similar to older fluorescent lamps (previously discussed) that aged unevenly: the flashes/luminance with one direction of line current may not equal those that occur in the other direction.

The above example also illustrates that it is possible for flicker in a lamp to have harmonics with multiple low-frequency components, here at both 60 Hz and 120 Hz.

5.3 PWM LED driving current frequencies in the range of 120 Hz to ~1 kHz

It was already mentioned that PWM is often used to dim LEDs by pulsing the current through them intentionally. The luminous intensity of the LED can be adjusted by varying the length of time that the LED current is High or Low. Thus, PWM dimming circuits may be designed to operate at any frequency, whether the input is dc or ac.

It is common to apply PWM dimming in frequencies 120 Hz and especially in the range of 200 Hz to 1 kHz. Furthermore, it should be mentioned that there are technologies that drive the LEDs with PWM signals even when not dimming. That is, the simple PWM square wave current is sent through the LED at all times and at full intensity. The frequency being utilized is often programmed into the driving controller. Therefore, it is often only a matter of software design to alter the PWM dimming frequency.

Typical circuits to achieve PWM dimming are shown in Figure 10. Two methods are common:

- A switch may be in series with the LED string, as in Figure 10(a). Then when the switch is on, the LED current is permitted to pass through. When the switch turns off, there is an open circuit, and the LED current becomes zero.
- In Figure 10(b), the switch is in parallel with the LED string. When the switch is off, all the current passes through the LED string. However, when the switch is on, it essentially becomes a short

circuit. The current from the dc-dc converter goes through the switch instead of the LEDs because it is the low impedance path.

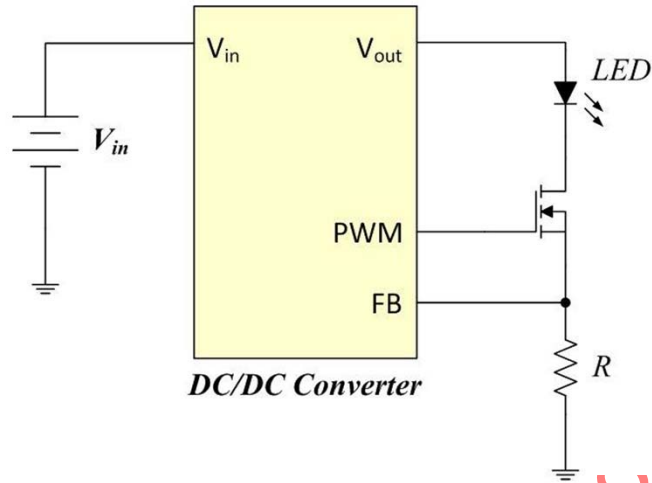

(a) Series PWM Dimming

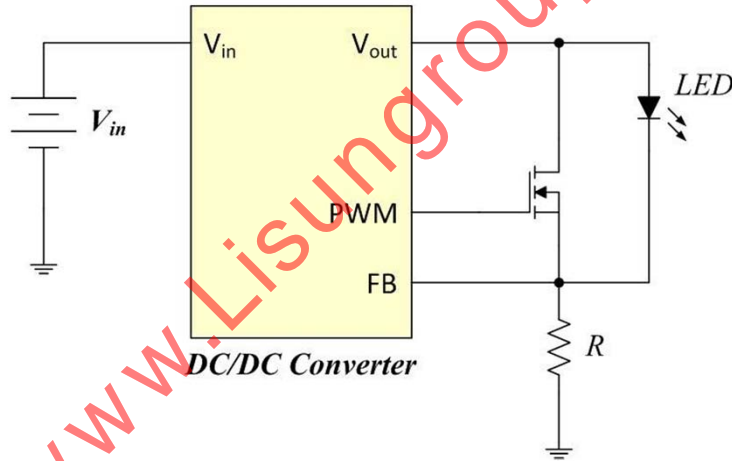

(b) Parallel PWM Dimming

**Figure 10—PWM dimming introducing flicker into LEDs
(Lehman and Wilkins [B73])**

In either case, the current is pulsing through the LEDs. The average value of the current is controlled by adjusting the duty ratio, d , of the current through the LED, which is the fraction of time that the current flows through the LED string ($0 < d < 1$). For example, Figure 11 demonstrates an example of how it is possible to keep the same dimmed current though an LED string. Both the analog dimmed currents and the PWM dimmed currents have the same averaged current. However, the PWM current has 100% flicker. The average value of the PWM dimmed current is adjusted by changing the duty ratio, d , which in the figure is nominally set to be 0.25. Keeping the same maximum value and increasing duty ratio would have the effect of increasing the average current and causing the lamp to become proportionally brighter. On the other hand, the dimming of the analog method would directly adjust the continuous value of the LED current and maintain 0% flicker while changing the dimming level of the circuit.

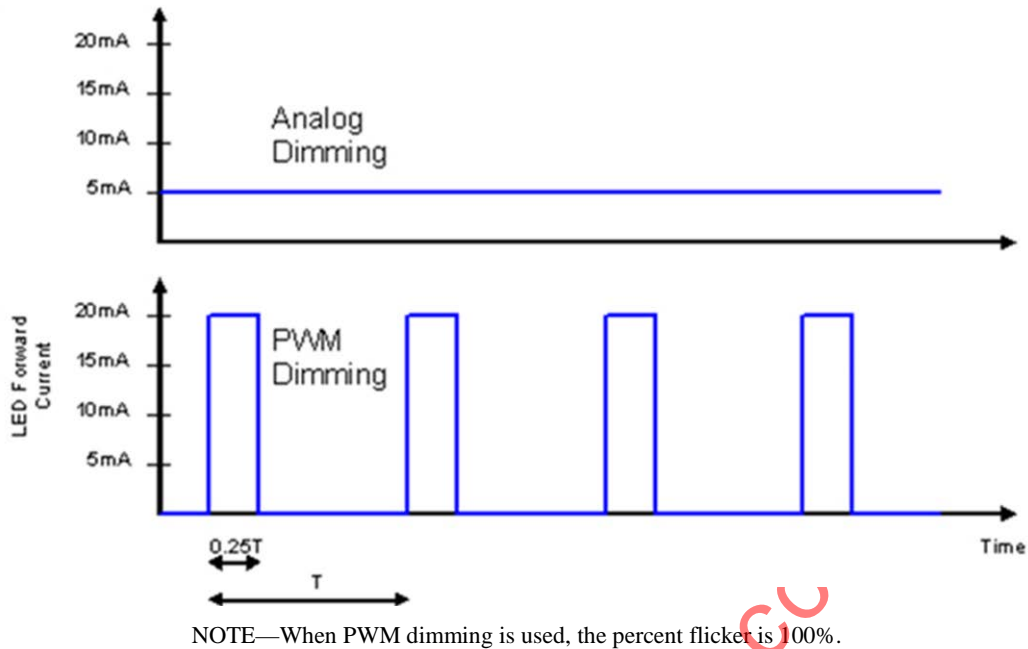

Figure 11—Analog and PWM dimming

5.4 Experimental measurements of flicker in various light sources⁶

Figure 12 shows flicker measured in a variety of traditional light sources, including examples of incandescent, halogen, and metal halide (MH) technologies (yellow icons), magnetically ballasted fluorescent technologies (red icons), and electronically ballasted fluorescent technologies (green icons). Figure 13 shows flicker measured in a variety of SSL sources. A number of observations can be readily made:

- Some SSL products currently on the market have equal or better flicker performance than traditional lighting technology.
- Some SSL products currently on the market are clearly well outside the flicker frame of reference established by traditional lighting technology, and modulating luminous flux in previously unseen manners.
- Flicker index and percent flicker correlate fairly well at lower levels of percent flicker (<40). However, shape variation captured by flicker index separates otherwise similar (same percent flicker) products at higher levels of percent flicker.
- SSL products currently on the market exhibit wide variation in flicker performance. Flicker performance is directly related to the LED power electronic driver because luminous intensity is (approximately) proportional to current through the LEDs.
- All of the SSL products are shown without dimmer.

⁶ The discussion in 5.4, including the figures, is taken from Lehman et al. [B71].

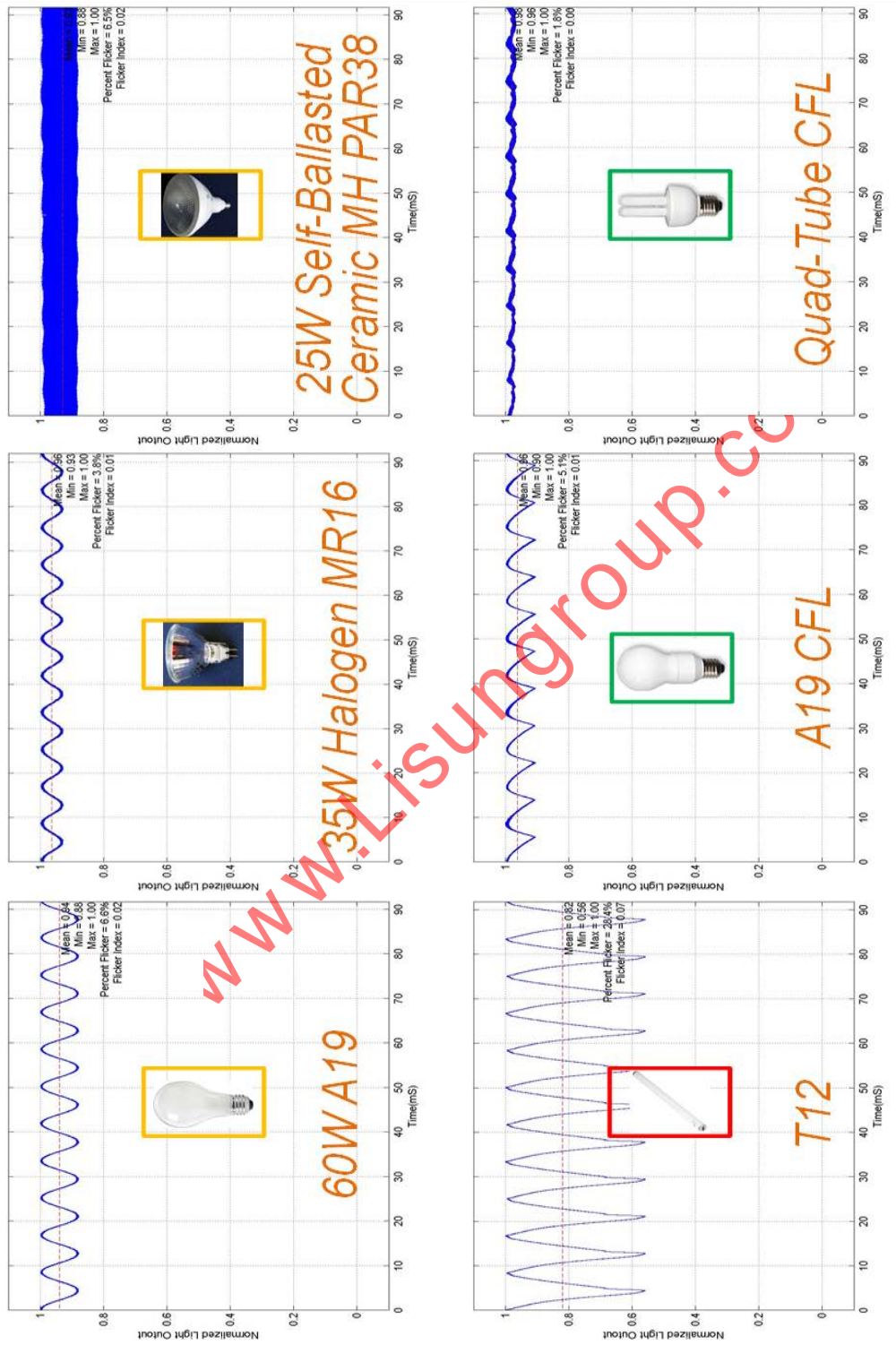

Figure 12—Experimental data of flicker in traditional lighting sources (Lehman et al. [B71])

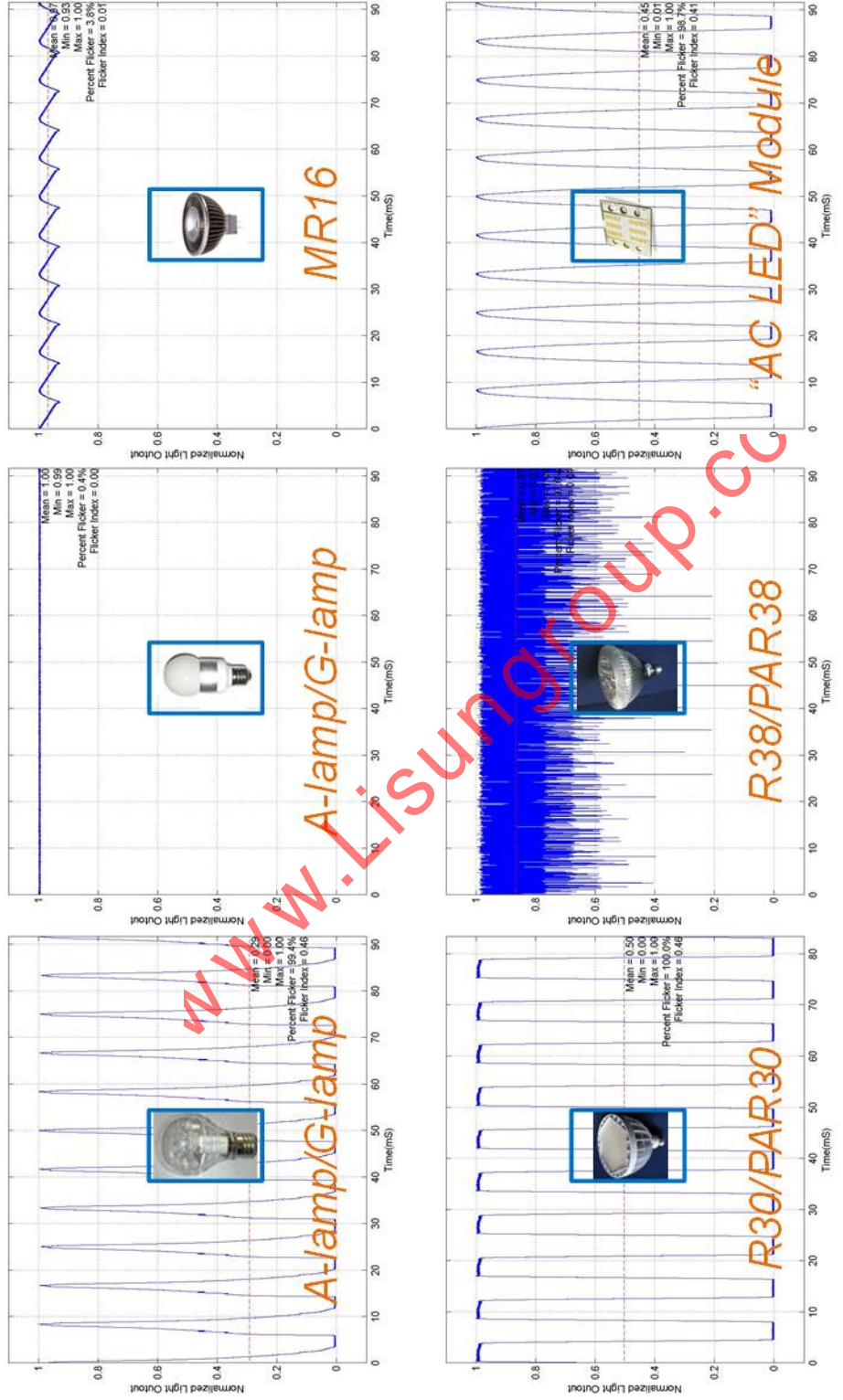

Figure 13—Experimental data of flicker in LED lighting sources (Lehman et al. [B71])

6. Biological effects of flicker⁷

This clause summarizes a public report created by the IEEE P1789 Working Group on LED, and the material has also been published (the full-length version of the report can be found at <http://grouper.ieee.org/groups/1789/>). The intention of this clause is to provide an objective summary of the reported potential effects on human health for both visible and invisible flicker and to draw attention to implications for the design of LED lighting. Specifically, Clause 6 documents

- a) Potential risks of seizures due to flicker at frequencies within the range of ~3 to ~70Hz
- b) Possible human biological effects due to invisible flicker at frequencies below ~165Hz
- c) The differences between “visible” flicker and “invisible” flicker and any relation to human biological effects

This clause is only an introduction to the possible adverse biological effects of flicker. Risk assessment of these potential biological effects is presented in Clause 7.

The potential health effects of flicker can be divided into those that may immediately result from a few seconds' exposure, such as the risk for epileptic seizures, and those that may be the less obvious result of long-term exposure, such as malaise, headaches, and impaired visual performance. The former are associated with visible flicker, typically within the range of ~3 to ~70 Hz; and the latter, with invisible modulation of light at frequencies above those at which flicker is visible (invisible flicker). Human biological effects of flicker are a function of the flicker characteristics (principally frequency and modulation depth), the characteristics of the stimulus (luminance, spectrum, size, contrast), characteristics of the individual (adaptation state of the eye, individual differences in sensitivity), and several other factors.

6.1 Photosensitive epilepsy

A low percentage of population (see Clause 7) is recognized as having photosensitive epilepsy. Repetitive flashing lights and static repetitive geometric patterns may induce seizures in these individuals. Some photosensitive people have not been diagnosed and may be unaware that they are at risk.

The seizures reflect the transient abnormal synchronized activity of brain cells, affecting consciousness, body movements, and/or sensation. The onset of photosensitive epilepsy occurs typically at around the time of puberty; in the age group of 7 to 20 years, the condition is five times as common as in the general population. Three quarters of patients remain photosensitive for life (see Harding and Jeavons [B42] and Fisher et al. [B32]). Many factors (see Fisher et al. [B32]) may combine to affect the likelihood of seizures including the following:

- **Flash frequency.** Any repetitive change in a visual stimulus within the frequency range of 3 Hz to 70 Hz is potentially a risk, and the greatest likelihood of seizures is for frequencies in the range of 15 Hz to 20 Hz; see Figure 14. The flashes do not have to be rhythmic.
- **Brightness.** Stimulation in the scotopic or low mesopic range (below about 1 cd/m²) has a low risk, and the risk increases monotonically with log luminance in the high mesopic and photopic range.
- **Contrast** with background lighting. Contrasts above 10% are potentially a risk.
- **Distance** between the viewer and the light source and its location, which determine
 - **Total area** of the retina receiving stimulation. The likelihood of seizures increases according to the representation of the visual field within the visual cortex of the brain. The cortical representation of central vision is greater than that of the visual periphery.
 - **Location** of stimulation within the visual field is important: Stimuli presented in central vision pose more of a risk than those that are viewed in the periphery, even though flicker in the periphery may be more noticeable.

⁷ Material from this clause is taken from Wilkins et al. [B117].

- **Wavelength** of the light. Deep red flicker and alternating red and blue flashes may present adverse health effects.
- **Open or closed eyes.** Bright flicker can present adverse health effects when the eyes are closed, partly because the entire retina is then stimulated. However, if flickering light is prevented from reaching the retina of one eye by placing the palm of a hand over that eye, the effects of the flicker are very greatly reduced in most patients.

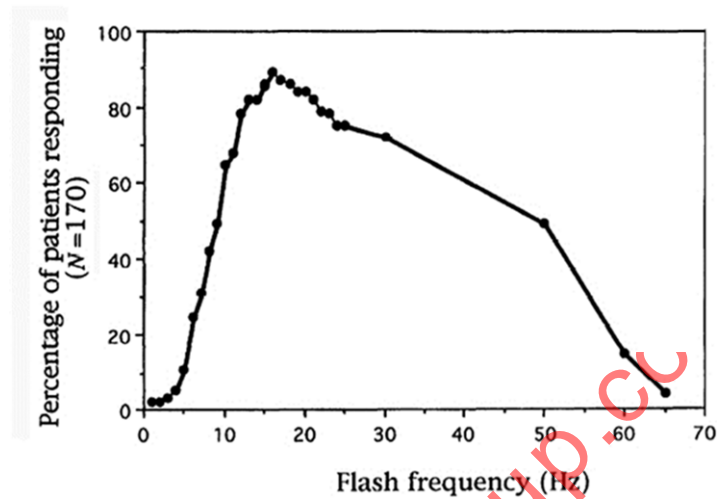

NOTE—Percentage of patients with photosensitive epilepsy exhibiting epileptiform EEG responses to the flicker from a xenon gas discharge lamp shown as a function of flash frequency (Wilkins et al. [B117]) (using the data from Harding and Jeavons [B46]).

Figure 14—Patients with photosensitive epilepsy

In addition, a substantial minority of patients (usually those who are sensitive to flicker) are sensitive also to spatial patterns; see Figure 15 for an example. About one third of patients are sensitive to patterns even when there is no flicker, and most are more sensitive to flicker if it is patterned (Harding and Jeavons [B46], Fisher et al. [B35], Wilkins [B113], and Wilkins et al. [B114]). The worst patterns are those of stripes in which one cycle of the pattern (one pair of stripes) subtends at the eye an angle of about 15 minutes of arc.



Figure 15—Escalator stair tread (Wilkins et al. [B117])

6.2 Invisible flicker

The frequency of the ac electricity supply is 60 Hz in America and 50 Hz in Europe; in Japan, both 50 Hz and 60 Hz are used in different regions. The circuitry in older fluorescent lamps with magnetic ballasts operate so that the lamps flash at twice the supply frequency (100 Hz or 120 Hz). However, as the lamps age, the flashes that occur with one direction of current may not equal those that occur with the other direction, and the lamps may emit flicker with components at the frequency of the electricity supply. It has been determined that photosensitive seizures should not occur if fluorescent lamps are operating properly. However, when the lamps malfunction and give flicker below 70 Hz, electroencephalograph (EEG) recordings indicate a risk of seizures (Binnie et al. [B8]). Nevertheless, some photosensitive patients have complained about normally functioning (older) fluorescent lighting (with magnetic ballasts).

Measurements of the electroretinogram have indicated that modulation of light in the frequency range of 100 Hz to 160 Hz and even up to 200 Hz is resolved by the human retina although the flicker is too rapid to be seen (Burns et al. [B13] and Berman et al. [B5]). In a cat, 100 Hz and 120 Hz modulation of light from fluorescent lamps has been shown to cause the phase-locked firing of cells in the lateral geniculate nucleus (LGN) of the thalamus, part of the brain with short neural chains to the superior colliculus, a body that controls eye movements (Eysel and Burandt [B33]). Several studies show that the characteristics of human eye movements across text are affected by modulation from fluorescent lamps and cathode ray tube displays (see Wilkins [B112] and Kennedy and Murray [B66]), and two studies have shown impairment of visual performance in tasks involving visual search as a result of flicker from fluorescent lamps (Jaen et al. [B62]). Under double-masked conditions, the 100 Hz modulation of light from fluorescent lamps has been shown to double the average incidence of headaches in office workers, although this effect is attributable to a minority that is particularly affected (Wilkins et al. [B116]).

Sensitivity effects due to flicker at frequencies above perception have also been observed in normal people with good vision and health. A substantial decrement in sensitivity to visible flicker at 30 Hz, used as a testing condition, occurs in normal observers when there is a prior exposure of only 2 minutes' duration with flicker frequencies about 20% above the observers' CFF (Shady et al. [B96]).

6.2.1 Modulation depth and the Fourier fundamental

The effects of flicker depend not only on the frequency of the flicker but also on the modulation depth and on other waveform metrics such as flicker index and duty cycle. For visible flicker, the amplitude of the Fourier fundamental predicts flicker fusion (de Lange Dzn [B26]). For invisible flicker, the effects of different waveforms have not been studied in detail. The peak-trough modulation depth of the 100–120 Hz flicker from older fluorescent lamps with magnetic ballasts varies with the component phosphors, some of which exhibit persistence, varying the chromaticity of the light through its cycle (Wilkins and Clark [B115]). The peak-trough modulation depth known to induce headaches from fluorescent lighting at 100 Hz is about 35% (Wilkins et al. [B116]). The present definitions for modulation do not distinguish the difference between low-frequency and high-frequency modulation. But for sufficiently high flicker frequencies, there appear to be limited human biological effects.

6.3 Summary of biological effects

The more common biological effects for affected individuals occur

- Immediately and
- From flicker that is visible.

The potential risks include seizures and may include less specific neurological symptoms including malaise and headache. Seizures can be triggered by flicker in individuals with no previous history or diagnosis of epilepsy.

The less common reported biological effects for affected individuals occur

- From flicker that is invisible and
- After exposure of several minutes.

Health effects from invisible flicker have been reported, including headaches and eyestrain. Table 1 summarizes the research to date on the biological effects of flicker.

Table 1—Flicker and biological effects (Wilkins et al. [B117])

Source of flicker	Frequency range	Biological effect	Evidence
Sunlight through roadside trees or reflected from waves	Various	Seizures	Clinical histories (Harding and Jeavons [B46])
Xenon gas discharge photo-stimulator	3 Hz to 60 Hz	Epileptiform EEG in patients with photosensitive epilepsy	Many clinical EEG studies, e.g., Harding and Jeavons [B46]
Malfunctioning fluorescent lighting	Large 50 Hz component	Epileptiform EEG in patients with photosensitive epilepsy	Binnie et al. [B8]
Television	50 Hz and 60 Hz (discounting 25 Hz component)	Epileptiform EEG in patients with photosensitive epilepsy	Many studies, e.g., Harding and Harding [B45] and Funatsuka et al. [B39]
Flashing televised cartoon	~10 Hz	Seizures in children with no previous diagnosis of epilepsy	Major incident (Okumura et al. [B80])
Normally functioning fluorescent lighting (50 Hz ballast)	100 Hz (small 50 Hz component)	Headache and eyestrain	Many anecdotes
Normally functioning fluorescent lighting (50 Hz ballast)	100 Hz (small 50 Hz component)	Headache and eyestrain	Double-masked study (Wilkins et al. [B116])
Normally functioning fluorescent lighting (50 Hz ballast)	32% modulation depth	Reduced speed of visual search	Two masked studies (Jaen et al. [B62])
Normally functioning fluorescent lighting (60 Hz ballast)	120 Hz	Reduced visual performance	Veitch and McColl [B107]
Normally functioning fluorescent lighting (50 Hz ballast)	100 Hz (minimal 50 Hz component)	Increased heart rate in agoraphobic individuals	Hazell and Wilkins [B49]
Normally functioning fluorescent lighting (50 Hz ballast)	100 Hz	Enlarged saccades over text	Wilkins [B112]
Visual display terminals	70–110 Hz raster	Changes in saccade size	Kennedy and Murray [B67]
Visual display terminals	~70 Hz raster		Many anecdotal reports of prolonged photophobia
Normally functioning fluorescent lighting	100 Hz and 120 Hz	Phase-locked firing of LGN neurons in cats	Eysel and Burandt [B33]
Various	Up to 162 Hz	Human electroretinogram signals at light frequency	Burns et al. [B13] and Berman et al. [B5]
Normally functioning fluorescent lighting (50 Hz ballast)	100 Hz	Inconsistent changes in plasma corticosterone levels in captive starlings	Maddocks et al. [B74]
Normally functioning fluorescent lighting (50 Hz ballast)	100 Hz	Mate choice in captive starlings	Evans et al. [B32]

6.3.1 A few general implications

Visible flicker is an undesirable attribute to any lighting system. Table 1 summarizes research that suggests, for both visible and invisible flicker (in the mentioned frequency ranges), there may be a special at-risk population for which flicker is more than just annoying in that it could be a potential health hazard. This, however, will depend on modulation depth, ergonomics, flicker parameters and their relation to perception, and the ability to measure/determine the influence of these parameters with human diagnostics.

- a) *Frequency*. Normally functioning fluorescent lighting controlled by magnetic ballast has been associated with headaches due to the flicker produced. LEDs driven so that they flicker at a frequency twice that of the ac supply may have a depth of modulation greater than that from most fluorescent lamps. The effects of the flicker are therefore likely to be more pronounced in these cases.
- b) *Field of view*. Point sources of light are less likely to induce seizures and headaches than a diffuse source of light that covers most of a person's field of vision. Flicker from LEDs used for general lighting may therefore be more likely to be a potential health hazard than that from LEDs used in instrument panels.
- c) *Visual task*. The invisible flicker described in Table 1 may be more likely to cause problems when the visual task demands precise positioning of the eyes, as when reading.
- d) *Spatial distribution of point sources of light*. Spatial arrays of continuously illuminated point sources of light may have the potential to induce seizures in patients with photosensitive epilepsy when the field of view is large and when the arrays provide a spatial frequency close to 3 cycles/degree (e.g., large LED public display boards viewed from close proximity).

7. Risk assessment

7.1 Introduction and summary

This clause on risk assessment serves to

- Identify circumstances under which flicker from lighting may produce adverse health effects in the general population and susceptible subpopulations.
- Assess the range of severity of each potential adverse health effect and the influential parameters that affect severity.
- Characterize the current state of knowledge and Expert Opinion for each potential adverse effect.
- Identify “Low-Risk Levels” or values of the influential parameters for which the probability and/or severity of potential adverse effects may be considered inconsequential, based on the available data.

As previously discussed, LEDs as a light source do not inherently flicker. Nevertheless, when coupled with their driving electronics, some (but not all) LED lighting products may exhibit more pronounced flicker than current fluorescent and incandescent lamps. This risk assessment was undertaken to collect what is known about potentially undesirable health effects of flicker especially because government and industry studies project that LED lighting products will account for as much as 50% of the lighting market by the year 2020.

The focus of this clause is on risk assessment for LED-based lighting, in other words, the derivation of risk level based on probability and severity of potential hazards. The corresponding risk levels, depicted as low, medium, serious, and high in this clause, need to be interpreted along with the contextual definitions as presented in the clause.

This clause does *not* address societal risk tolerance. Risk assessment helps to quantify the relative magnitude of potential harm and to enable a value judgment about the acceptability of potential risks. When integrated with considerations of uncertainties, costs, benefits, and social values, risk tolerance is formed. Management of consumer product risk by society is a complex, multifaceted process, as evidenced by the vast range of legally available products that are associated with risk. This clause is intended to serve as a tool for risk communication and management and makes no conclusions regarding levels of risk that are acceptable to society. Based on the results presented on risk assessment, it is possible to create recommended practices in the next clause.

Potential major adverse effects of flicker identified in published research and/or Expert Opinion include these five factors:

- Photoepilepsy or flashing-light induced seizure.
- Stroboscopic effect and associated apparent slowing or stoppage of rotating machinery.
- Migraine or severe paroxysmal headache often associated with nausea and visual disturbances.
- Increased repetitive behavior among persons with autism.
- Asthenopia, including eyestrain, fatigue, blurred vision, conventional headache, and decreased performance on sight-related tasks.

Other potential effects of flicker that have received less attention include panic attack, anxiety, and vertigo and are also briefly discussed.

This risk assessment is based on a hypothetical exposure scenario in which 100% of the U.S. population is exposed at least once per year to flicker that has the potential to engender any of the five effects listed above. Under this assumption, the risk level(s) derived here for each effect are shown in Figure 16 with accompanying definitions in Table 2 and Table 3. The color saturation associated with each potential hazard indicates degree of certainty, where greater saturation corresponds to greater certainty and conversely, lesser saturation corresponds to greater uncertainty. Low-Risk Levels are indicated in Figure 17 by “low-risk” scenarios. Low-Risk Levels for all adverse effects are shown in Figure 18 in the form of a graph relating frequency and modulation depth. Whereas low frequency with high modulation produces visible flicker that can have immediate effects (e.g., possible risks of seizures), the potential effects of low-modulation high-frequency flicker are less obvious and may take minutes to emerge (e.g., headaches).

It is important to note that risk tolerance may or may not be commensurate with risk level. For instance, in the United States, the risk of foreign body fatalities is “high” for coins among children 4 years old and younger, though coins are still widely used in circulation. Conversely, the risk of bovine spongiform encephalopathy (BSE, or “mad cow disease”) is considered as “low” utilizing the risk matrix in this document, yet immediate risk mitigation was engaged by literally all governments where BSE incidents were reported.

This study is limited by the scope of the IEEE P1789 Working Group and excludes other potential hazards of lighting not directly related to flicker.

7.1.1 Assumptions

The distribution of light flicker characteristics among LED lights that will populate the future marketplace is unknown. There is no innate flicker hazard in LED lighting. However, it is assumed that flicker characteristics of future LED lights will not be fully controlled and that nearly all of the U.S. population will be exposed to a possibly undesirable condition created by flicker at least once during a one-year timespan. This is a conservative assumption but may not be unreasonable (particularly for invisible flicker) given the projection of continuous growing popularity of LEDs for both commercial and residential uses, and the short exposure time associated with some potential flicker-related health effects. Furthermore, *flicker* in this recommended practices document is meant to describe steady-state periodic variations and not transient or intermittent behaviors.

Table 2—Risk matrix

Severity	Probability				
	Very low	Low	Medium	High	Very high
Mild					
Harmful					
Severe					
Catastrophic					

Table 3—Risk levels

Risk level	Color code
Low	
Medium	
Serious	
High	

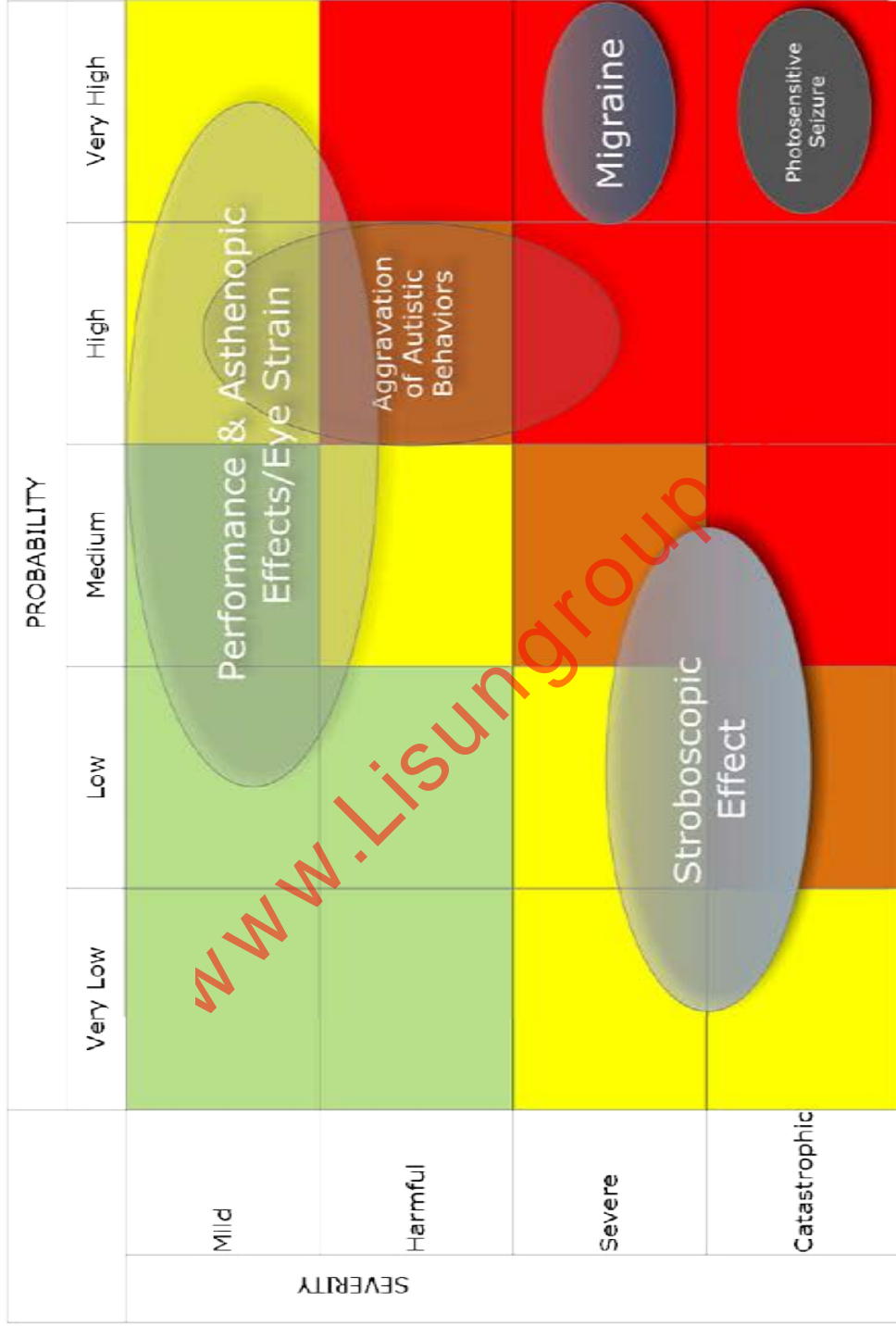

NOTE—Greater saturation corresponds to greater certainty.

Figure 16 — Risk matrix by hazard

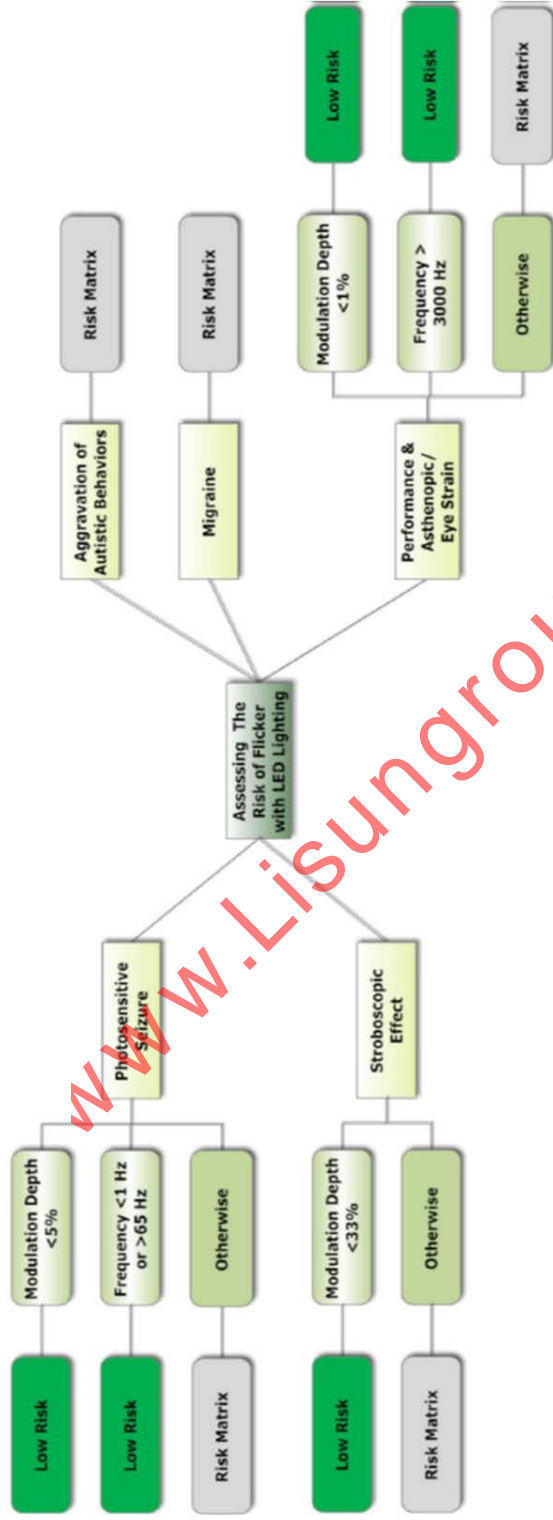
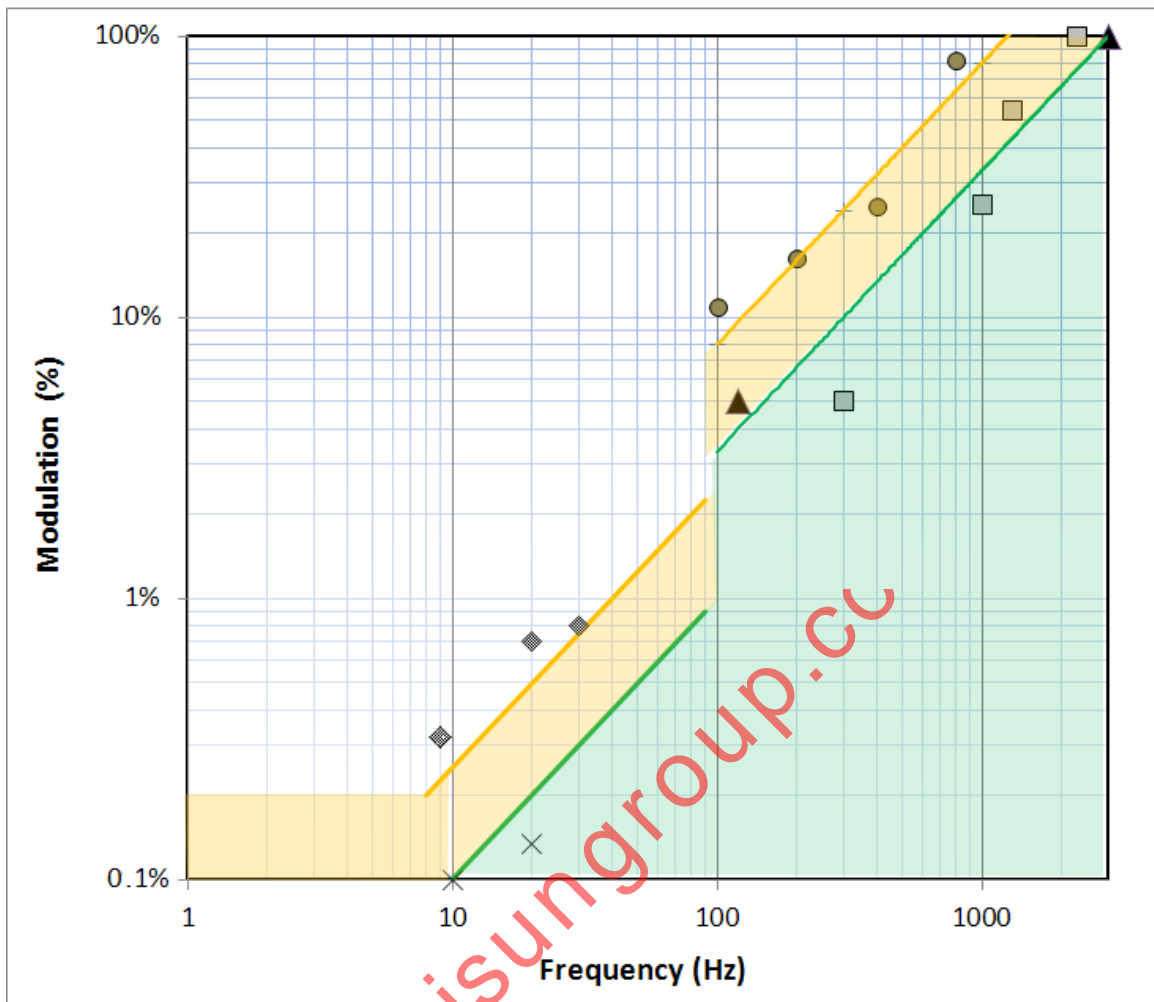

Figure 17 — Risk levels for the five identified adverse effects as affected by the two principal LED flicker characteristics and emphasizing low risk by green



NOTE 1—Modulation (%) is defined as the difference between maximum and minimum luminance divided by the sum of maximum and minimum luminance (multiplied by 100), i.e., Michelson contrast (see Clause 4).

NOTE 2—The no-effect region is shown in green and the low-risk region includes any of the shaded region (green or orange).

NOTE 3—The data are taken from the classic data of Kelly [B64] (diamonds) and Perz et al. [B81] for visible flicker, from Bullough et al. [B12] (squares) and Perz et al. [B82] (circles) for stroboscopic effects, and Roberts and Wilkins [B92] (triangles) for the intrasaccadic perception of phantom arrays. Data from Perz et al. [B81] and [B82] are taken from the lowest level of the whiskers in their box-and-whisker plots (see Clause 8 for explanation). Above the flicker frequency of 90 Hz, the upper margin for the no-effect region is given by the line $\text{Modulation (\%)} < 0.0333 \times \text{Frequency}$.

NOTE 4—The upper limit of the low-risk region is the line $\text{Modulation (\%)} < 0.08 \times \text{Frequency}$ and corresponds to a factor of about 2.5 above the NOEL. Below 90 Hz, the low-risk region satisfies $\text{Modulation (\%)} < 0.025 \times \text{Frequency}$, and the NOEL can be taken a factor of 2.5 below that to become $\text{Modulation (\%)} < 0.01 \times \text{Frequency}$. The conservativeness of the regions may be determined by further research, but based on the available data (see Clause 8), the shaded regions contain the low-risk region.

Figure 18—Low-Risk Level and no observable effect level (NOEL)

7.2 Methodology

This risk assessment follows the method developed by the Eurosafe Working Group on Risk Assessment (Rider et al. [B90]) and is similar in form to the SCENIHR “Scientific opinion on light sensitivity” [B95]. Risk has two distinct components: hazard and exposure. Consequently, risk level is determined by the severity and probability of the adverse event under evaluation. Risk assessment requires a disciplined approach that starts with determining all the influential parameters affecting the probability and potential severity of the event. This approach is best accomplished by a team of experts in the relevant disciplines (where the selection of influential parameters is based on reasonable knowledge of causation rather than solely on correlation.)

Not all data are equal with regard to certainty level. The following data categorization terms are used in this clause:

- *Solid Data* – representative, validated, demonstrates causation.
- *Data* – representative, demonstrates causation, but not validated.
- *Limited Data* – not representative, demonstrates causation, not validated.
- *Expert Opinion* – opinion of subject matter expert in appropriate discipline in the absence of data.
- *Opinion* – best guess, not representative, not validated, weak causation.

When terms such as *Limited Data* or *Opinion* are used, they are intended to imply that more research is needed. They do not refer to quality of existing opinion or data. Similarly, the lengths of the subclauses covering individual hazards are generally determined by the quantity of data available and do not reflect the level of importance or priority attributed to the hazard by the authors of this document.

The following terms are used in the above data categorization:

- *Representative* – a small quantity of data whose characteristics represent (as accurately as possible) the entire population or subpopulation under consideration.
- *Validated* – presence of evidence that a certain result/conclusion is replicated/supported by peer-reviewed studies.
- *Causation* – indication of direct cause-and-effect relationship based on a reasonable understanding of the mechanism as opposed to speculated dependency with no/limited support.
- *Correlation* – a measure of the (not necessarily causal) relationship or dependence between two variables.

The term *Low-Risk Level* is widely used in this risk assessment. As used here, the Low-Risk Level is similar to the low-risk level used in toxicology to indicate the maximum dose of a substance that produces no observable health effects. As used in this risk assessment, Low-Risk Level denotes the value of an influential parameter corresponding to a transition between presence and absence of an observable effect in a subpopulation assuming “worst-case” values of other influential parameters. The term *no observable effect level (NOEL)* is used in Figure 18. The NOEL is commonly defined in toxicology as “an exposure level at which there are no statistically or biologically significant increases in the frequency or severity of any effect between the exposed population and its appropriate control” (“Vocabulary Catalog” [B108]).

The exposure assessment portion of this risk assessment is particularly difficult due to the level of uncertainty. Typically in risk assessment, exposure is expressed as the likely dose (e.g., duration of contact/exposure, frequency of use/exposure) of the hazard (e.g., flicker) to which the consumer may be subjected. Following that, a “critical path to injury” can be developed to derive the probability of injury level (e.g., what is the probability for flicker to fall in the range of potentially hazardous modulation depth and/or flicker frequency, and consequently result in a possible adverse health effect).

In this case, the distribution of flicker characteristics among LED lights that will populate the future market place is unknown. It is assumed here that flicker characteristics of future LED lights could be uncontrolled and that nearly all of the U.S. population will be exposed to a potentially hazardous condition created by flicker at least once during a one-year timespan. This is a conservative assumption but is not unreasonable

(particularly for invisible flicker) given the projection of continuously growing popularity of LEDs for both commercial and residential uses, and the short exposure time associated with some potential flicker-related health effects. The susceptible and general populations were not discussed separately mainly due to the fact that the size of susceptible population is still significant considering a) the three hundred million people in the United States and b) the probability level set for “very high” for typical risk assessments for consumer goods is a small number (e.g., 10 per million).

Potential hazards of LED lighting consistent with the scope of the IEEE P1789 Working Group effort are reviewed below. For each potential hazard, the epidemiology, severity, susceptible subgroups, and identity (values) of influential parameters are considered. Other possible negative lighting features, including those associated with wavelength (e.g., blue light hazard, ultraviolet), glare, and periodic arrays or patterns of lights are not considered. Influential parameters are identified where possible, along with categorization of data certainty level. Where possible, Low-Risk Levels are indicated.

7.3 Terms used in the risk assessment

This risk assessment involves five probability levels, four severity levels, and four risk levels. The probability levels are defined in Table 4, and the severity levels, in Table 5. The risk levels are defined in the risk matrix shown in Table 6 using the color chart shown in Table 7. The probability, severity, and risk levels are similar to those used, for example, in the development of the European Community Rapid Information System (Kuneva [B70]).

Table 4—Definition of probability levels

Probability	Potential injuries per million
Very Low	(0 to 0.01)
Low	(0.01 to 0.1)
Medium	(0.1 to 1)
High	(1 to 10)
Very High	(10 to 1000000)

Table 5—Definition of severity levels

Severity	Impact on individual
Mild	<ul style="list-style-type: none"> — Mild discomfort or fatigue — Malaise — Mildly decreased ability to concentrate
Harmful	<ul style="list-style-type: none"> — Sickness that does not require multiple workday absences — Measureable impaired visual performance — Vomiting — Significant discomfort — Significantly decreased ability to concentrate
Severe	<ul style="list-style-type: none"> — Hospitalization — Sickness requiring multiple missed workdays — Substantial impaired visual performance including blurred vision — Severe photophobia — Seizure
Catastrophic	<ul style="list-style-type: none"> — Death — Permanent injury/loss of life, limb, or function

Table 6—Risk matrix

Severity	Probability				
	Very low	Low	Medium	High	Very high
Mild					
Harmful					
Severe					
Catastrophic					

Table 7—Risk levels

Risk level	Color code
Low	
Medium	
Serious	
High	

7.4 Risk assessment of different biological effects of flicker

7.4.1 Photosensitive seizure

Seizure provoked by flickering lights is the most thoroughly studied hazard within the scope of IEEE Std 1789. The overwhelming majority of studies cover changes in luminance. Potential hazards of alternating colors with minimal change in luminance are less thoroughly investigated.

The prevalence of photosensitivity was reviewed in 2005 by Fisher et al. [B35] who wrote “Photosensitivity, an abnormal EEG response to light or pattern stimulation, occurs in ~0.3–3% of the population. The estimated prevalence of seizures from light stimuli is ~1 per 10,000, or 1 per 4,000 individuals’ age 5–24 years. People with epilepsy have a 2–14% chance of having seizures precipitated by light or pattern”; however, Fisher et al. [B35] acknowledge a wide variation in epidemiological estimates: “The prevalence of ‘photosensitivity’ has been said to range from less than one in 10,000 to ‘5–9%’”, noting that “This wide variance stems mainly from two factors: lack of clarity in what condition is being reported, and bias in referral populations.”

In a review published one year earlier, de Bittencourt [B23] wrote “Very few studies of photosensitivity or visual sensitive epilepsy could be called epidemiologic in the strict sense, that is, giving well-based incidence and prevalence rates of a well-defined clinical and electroencephalographic syndrome or group of syndromes. The available data suggest that photosensitivity is rare in the population as a whole, with an annual incidence rate around one case per 100 000 population. The incidence goes up to almost six per 100 000 in the late adolescent period, the age group at the highest potential risk. Well-established concepts, such as statements that one in 4000 of the general population or that 10% of all epilepsy patients would be photosensitive, should be reevaluated. The more likely figures are a lifetime prevalence of one in 10 000 in the general population, perhaps as low as 2%, of the epilepsy population. Further epidemiologic studies, sensu strictu [sic], are warranted to settle the basic question of the real incidence and prevalence of photoparoxysmal responses (PPRs) and epilepsy with seizures provoked by visual stimuli in the community.”

Further estimates of the prevalence of photosensitivity can be derived from the “Pokemon Incident” in which approximately 560 seizures were linked to viewing of a single episode of the children’s television program “Pokemon” containing an approximately 4-second-long segment of 12.5 Hz blue-red flicker (Fisher et al. [B35]).

7.4.1.1 Influential parameters

The risk (of seizures) is known to depend on the following factors:

- The flicker frequency
- The light intensity
- The change in light intensity over time (modulation depth)
- The spectral composition of the light
- A variety of other factors relating to the neurology of the visual system such as
 - Whether one or both eyes are stimulated
 - The area of the retina receiving stimulation
 - Whether the central or peripheral retina is stimulated

In a published expert consensus statement, the Epilepsy Foundation of America Working Group (Harding et al. [B44]) identified the following influential parameters and values for seizure provoked by flashing lights: “A flash is a potential hazard if it has luminance ≥ 20 cd/m², occurs at a frequency of ≥ 3 Hz, and occupies a visual solid angle of ≥ 0.006 steradians ($\sim 10\%$ of the central visual field or 25% of screen area at typical viewing distances)⁸. A transition to or from saturated red also is considered a risk.” Additional detail, including an extensive reference list and survey of additional influential parameters, is provided in the Working Group’s review (Fisher et al. [B35]): “Frequencies in the range of 15 Hz –25 Hz are most provocative, but some individuals are sensitive to single flashes or to frequencies as high as 65 Hz.” Note that by defining a flash as a change in luminance of ≥ 20 cd/m², the consensus statement combines the effects of light intensity (time-averaged luminance) and its variation over time (modulation). The statement recognizes that for flashes less than 20 cd/m², the risk may be less because the time-averaged luminance is low, but that as the time-averaged luminance increases, lower and lower modulations may be capable of inducing a seizure. The statement was designed for use with displays having a typical luminance of about 200 cd/m² for which a flash of 20 cd/m² provides about 5% modulation depth. For brighter light, a critical Modulation (%) (Michelson contrast) threshold of 10% has been assumed (Smedley et al. [B100]).

7.4.1.2 Initial risk assessment for photoepilepsy

A risk decision tree for photoepilepsy is shown in Figure 19. Logic behind the decision tree is as follows:

According to the severity definitions in Table 5, seizures are regarded as severe.

According to information on incidence of photoepilepsy presented earlier in this clause and the probability definitions in Table 4, the probability of seizure for all identifiable subgroups would be categorized as “very high” if the three physical conditions for potentially hazardous flicker (solid angle, flash rate, modulation depth) are met. In this case, the risk matrix in Table 6 indicates a high-risk level (red).

No information on the probability of seizure has been located for flicker that meets zero, one, or two (but not all three) of the flicker hazard criteria (solid angle, flash rate, modulation depth).

Assuming that the probability of seizure is low or very low (see Table 4) for flicker meeting zero, one, or two (but not all three) of the conditions for hazardous flicker, the risk matrix indicates medium risk level (yellow). The decision tree in Figure 19 is based on this assumption.

If it is assumed that the probability of seizure is medium when zero, one, or two (but not all three) conditions for potentially hazardous flicker are met, then a more complicated decision tree incorporating more risk levels is necessary.

⁸ From the minimal expected viewing distance, the total area of concurrent flashes subtends at the eye a solid angle of >0.006 steradians. This solid angle equates to one fourth of the area of the central 10° of the visual field. For practical purposes, the area can be taken as applying to an area $> 25\%$ of the area of a television screen, assuming standard viewing distances of ≥ 2 m (~ 9 feet).

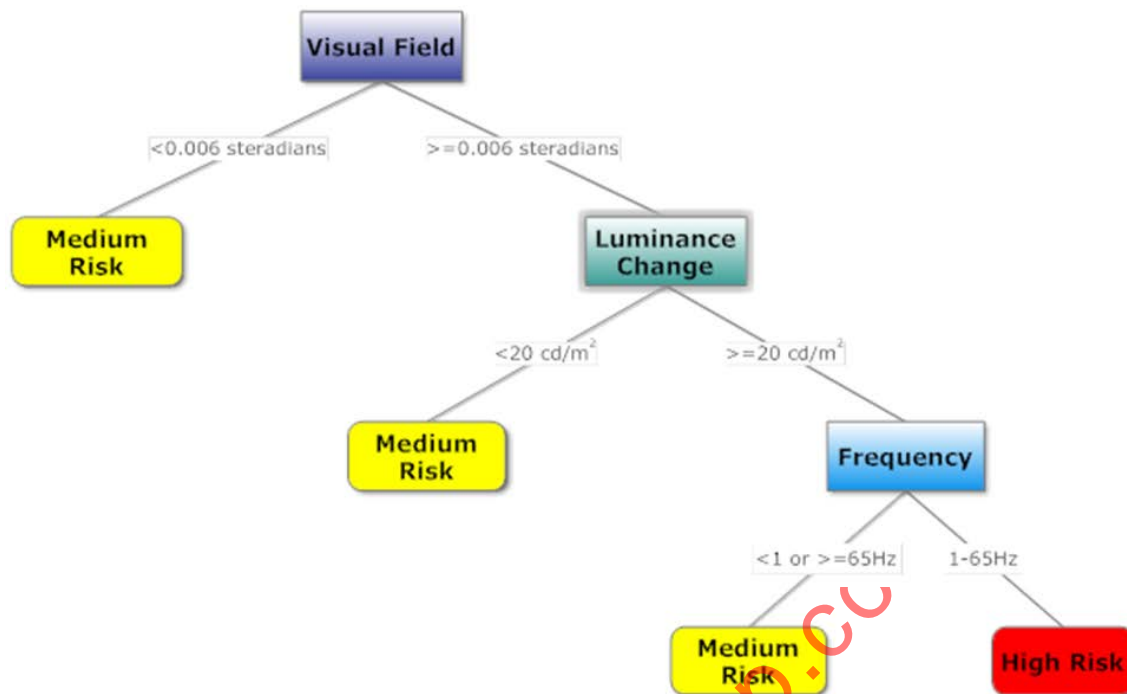

Figure 19—Decision tree for photoepilepsy

7.4.1.3 Conclusions

Solid Data and Expert Opinion exist for photosensitive seizure. Susceptible subgroups have been identified as individuals aged 5 to 24 years. Estimated prevalence of seizures can range from 1 per 100 000 to 1 per 4000. Influential parameters have been identified and values set with consensus support from experts.

7.4.1.4 Low-Risk Levels

Expert Opinion within the IEEE P1789 Working Group suggests that 5% modulation depth (Michelson contrast) can serve as a frequency-independent Low-Risk Level for seizure. The Epilepsy Foundation of America Working Group provided guidelines of 20 cd/m^2 for luminance change and 3 Hz to 65 Hz for frequency.

7.4.1.5 Comments

It is assumed that the solid angle requirement (≥ 0.006 steradians) will be met in general interior lighting applications. The mean luminance requirement of 20 cd/m^2 will also be met. The modulation depth (Michelson contrast) of $>5\%$ may or may not be met.

7.4.2 Stroboscopic effect

The stroboscopic effect (strobe effect, wagon wheel effect, stagecoach wheel effect, reverse rotation effect) refers to a class of optical illusions in which the appearance of rotating or otherwise moving objects is altered through intermittent illumination. Examples include apparent stationary appearance, reverse rotation, and change in speed. The stroboscopic effect can create a potentially hazardous condition in which the likelihood of accidents may be increased. The existence of the stroboscopic effect is supported by Solid Data; however, very little research exists on the epidemiology of injury associated with the stroboscopic effect or the nature and value of the influential parameters.

Eastman and Campbell [B30] studied rotating disks illuminated by fluorescent lights equipped with different ballasts but reported that “No quantitative data could be obtained by this method, except very rough estimates, but qualitatively the systems were arranged in the same order as indicated by the Flicker Indexes calculated from the oscilloscope traces.”

Frier and Henderson [B38] studied the stroboscopic effect of HID lamps [mercury, high-pressure sodium (HPS), MH] in various situations, noting that the stroboscopic effect becomes most noticeable when rotating machinery is used in industrial plants. They demonstrated this using a rotating bicycle wheel, and the spokes produce the stroboscopic effect. The effect was noticed for various lamps tested, even for split- or three-phase systems. Rea and Ouellette [B88] studied table tennis under HID lighting using HPS and MH lamps with single- and triple-phase power. They reported no significant effect on player performance but a significant effect on spectators (for whom the ball traversed field of view). They noted that “the stroboscopic effect was very important to the spectators” and that “stroboscopic motion was very noticeable under single phase line current with HPS lamps, but generally not noticeable with triple-phase line current or MH lamps. Unsolicited comments from the spectators indicated that ‘the ball was hard to see’ with single phase HPS lighting.” The single-phase HPS was characterized by 84% flicker and Flicker Index of 0.25 while the single-phase MH lamp (next highest flicker) had 51% flicker and Flicker Index 0.15. No implications of possible hazard were discussed.

Possibly the most thorough study of visual illusions created by intermittent illumination of machinery appears to be unavailable (Cates [B17]).

Bullough et al. [B12] investigated stroboscopic effects caused by solid-state lighting (SSL) using a variety of waveforms and frequencies ranging from 50 Hz to 300 Hz. They report that stroboscopic effects could be perceived at 300 Hz, but that “reducing the modulation from 100% flicker⁹ to 33% flicker¹⁰ was successful at reducing perception of stroboscopic effects.” They also noted that subjects were “more likely to detect a stroboscopic effect under 100% flicker with a frequency of 300 Hz, than under 33% flicker at 120 Hz” and that “stroboscopic effects under the 10% duty cycle appeared to be more prominent than under any of the conditions with higher duty cycles.” In more recent work, Bullough et al. [B11] created mathematical models to describe the relation between percent flicker, flicker frequency, and the percent of people that could detect the stroboscopic effect. Similarly, they introduced a measure of acceptability of viewers to any noticeable flicker. (On this scale: 0 indicated a score of neither acceptable nor unacceptable; +1 indicated a score of somewhat acceptable; and +2 indicated a score of very acceptable.) It was demonstrated that stroboscopic effect may be reported at very high frequencies. However, a very high acceptability level of above 1.5 could be maintained when flicker frequency was above 1500 Hz, even though the stroboscopic effect may have been reported.

Perz et al. [B82] describe the perception of stroboscopic flicker of a white dot on a black rotating turntable, revolving at a certain fixed speeds. Three separate experiments were performed to predict the visibility of the stroboscopic effect. The observer reported the presence or absence of the stroboscopic effect, and a 50% threshold was obtained by increasing frequency in interleaved staircases with an initial dc standard for comparison. The study presents formulae for visibility thresholds that depend on the Fourier components of the flicker waveform. For sufficiently low modulation depths, it is shown that the visibility of the stroboscopic effect can be seen up to at least 800 Hz, the highest frequency tested.

In addition to the “conventional” stroboscopic effect, it is well established that flicker of stationary objects at frequencies well above the limit of direct perception can create visual illusions when viewed during a saccade. So-called phantom arrays (Hershberger [B51]) have been documented with lights flashing as fast as 500 Hz (Hershberger et al. [B50]). Roberts and Wilkins [B92] showed that the phantom array enabled observers to discriminate flickering from steady light under two alternative forced choice conditions at frequencies up to 2500 Hz. Specifically, the mean of the individual thresholds at 100% modulation with 40° saccade was 2000 Hz and for 20° saccade was 2500 Hz. In both cases, the mean fell to chance (random guessing) at 3000 Hz.

⁹ 100% flicker defined as $100 \times (\max - \min) / (\max + \min)$, Flicker Index 0.5.

¹⁰ 33% flicker defined as $100 \times (\max - \min) / (\max + \min)$, Flicker Index 0.17.

There exists Expert Opinion that the stroboscopic effect can be hazardous. For example, Ridley and Channing [B91] state that “. . . it can cause a piece of rotating machinery to appear stationary or to be rotating slowly when, in fact, it is rotating at many times a second. This can be extremely dangerous.”

DeRoos [B27] states that “Another concern in the shop area is the stroboscopic effect of high intensity lights. When a high intensity lamp such as a mercury vapor lamp is used, brief, intense bursts of light energy may at times be in synchrony with the movement of a piece of shop equipment, such as a table saw. Hazard results when this synchronized movement gives the impression that the saw blade is standing still. To prevent this from happening, fixtures can be connected on three-phase wiring with alternate fixtures on different phases. The reason this is mentioned in conjunction with energy conservation is that high-intensity lamps may be substituted because they require less energy.”

BI EN 12464-1:2011 [B7] states that “Stroboscopic effects can lead to dangerous situations by changing the perceived motion of rotating or reciprocating machinery” and “Lighting systems should be designed to avoid flicker and stroboscopic effects.”

7.4.2.1 Influential parameters

Existing Data and Expert Opinion indicate depth of modulation and frequency to be among the more important influential parameters affecting the severity of the stroboscopic effect. Duty cycle and wave shape also have influence.

7.4.2.2 Conclusion

Solid Data exist for the existence of the stroboscopic effect; however, no epidemiological or etiological studies of hazard have been identified. Limited Data exist on the nature and value of the influential parameters. Modern experts appear to agree that the stroboscopic effect may be associated with hazards that could be severe or catastrophic in severity; however, no published studies of injury epidemiology or potentially susceptible subgroups have been located.

7.4.2.3 Low-Risk Level

Further research is needed to establish a Low-Risk Level. Based on work of Bullough et al. [B12] and [B11], Perz et al. [B81] and [B82], Roberts and Wilkins [B92], Lehman and Wilkins [B73], and Vogels et al. [B109], Low-Risk Level for modulation depth will depend on frequency as shown in Figure 18. Further discussion and justification of Figure 18 is given in Clause 8.

7.4.3 Migraine

Migraines are typically debilitating headaches often accompanied by other symptoms such as nausea, vomiting, photophobia, phonophobia, blurred vision, and cognitive disturbances.

Stovner et al. [B104] undertook an extensive study of global migraine epidemiology including a review of 107 previous global, continental, and national studies. They reported that 11% of people worldwide have active migraine disorders. Adults are more likely to suffer from migraines than children, and women are more likely to have migraines than men. Results vary considerably between the cited studies. For example, a study conducted in the United Kingdom in 1975 by Waters and O’Conner [B110] found between 23% and 29% of women and between 15% and 20% of men to be migraine sufferers.

Numerous environmental factors can act as migraine triggers, including flicker; however, few if any studies exist that list or quantify influential parameters for flicker-induced migraine. The studies relevant to flicker and migraines mentioned below, and references in those studies, emphasize patient-reported flicker effects on migraines (visible flicker likely below 70 Hz).

According to the National Headache Foundation [B78], “Many migraine sufferers are very sensitive to light, especially to glare. Bright lights are more likely to trigger migraine headaches when they are of a

“flickering” quality, and a slow flicker is usually more irritating than a more rapid one.” In addition, “Some fluorescent lighting or the light that flickers from television and movie screens may have a similar effect.”

Various studies have noted differences in EEG response to flicker between migraine sufferers and persons who do not experience migraines (e.g., Smyth and Winter [B102]); however, these studies do not provide details of flicker as a trigger factor for migraines.

According to work cited by Debney [B24], approximately 25% to 50% of migraine sufferers cite flicker as a trigger for migraine, and in a single study, 84% of children suffering from migraine cited stroboscopic effects as a trigger. In a very recent survey, Shepherd [B98] found that 22% of responding migraineurs cited flicker as a trigger for migraine; however, Shepherd also highlighted the lack of existing information on flicker and other visual stimuli as migraine triggers: “There are guidelines to avoid visual triggers of photosensitive epilepsy (although they are not always followed, as demonstrated by reports of seizures triggered while watching flickering images on television as recently as 2007). What is surprising is the lack of research on factors that can provoke headache and migraine, despite much higher prevalence rates.”

According to a review by Harle and Evans [B47], Debney [B24] found that flicker events precipitating migraine included “television; cinema; faulty fluorescent lighting; lighting in vehicular tunnels; flashlights; headlights; stroboscope; travelling past railings, telegraph poles and fences (by train).” This is corroborated by Shepherd [B98].

7.4.3.1 Influential parameters

Limited Data exist on influential parameters. A single case report was located (Kowacs et al. [B68]) involving a 25-year-old male who suffered migraines consistently when viewing a 60 Hz computer screen but encountered no ill effects from the same screen when the refresh rate was set to 75 Hz.

7.4.3.2 Conclusions

Data and Expert Opinion exist that flicker can trigger migraines. Very Limited Data and Expert Opinion exist on the nature or range of influential parameters. Solid Data exist on the epidemiology of migraines. Limited Data exist on the fraction of migraine sufferers for whom flicker acts as a trigger.

7.4.3.3 Low-Risk Level

No information available.

7.4.4 Aggravation of autistic behaviors

Concern about flicker from fluorescent lighting is common among educators working with autistic children and adults. For example, according to Grandin [B40], “Some autistic people are bothered by visual distractions and fluorescent lights. They can see the flicker of the 60-cycle electricity. To avoid this problem, place the child’s desk near the window or try to avoid using fluorescent lights. If the lights cannot be avoided, use the newest bulbs you can get. New bulbs flicker less. The flickering of fluorescent lights can also be reduced by putting a lamp with an old-fashioned incandescent light bulb next to the child’s desk.”

Numerous epidemiological studies of autism and related pervasive developmental disorders have been conducted. In this risk assessment, it is assumed that the prevalence of autism is about 0.1% based on a meta-analysis by Williams et al. [B118] and a review by Fombonne [B37]. Recently, a 2012 report by the Centers for Disease Control in the United States suggests that 1 in 68 children has been identified with an autism spectrum disorder (ASD) (Baio [B3]). However, no study describing epidemiology of flicker sensitivity in this group has been identified.

Few, if any, studies identify influential flicker parameters for persons with autism. There are indications that fluorescent lights with magnetic ballasts can be problematic. Fenton and Penney [B34] reported that “Repetitive behaviors of five autistic and five intellectually disabled children were observed under both fluorescent and incandescent lighting conditions. Findings supported the hypothesis that autistic children engage in a significantly greater frequency of stereotypes under fluorescent lighting, while there is no significant difference among intellectually disabled children when exposed to different lighting conditions.”

7.4.4.1 Influential parameters

Opinion exists on influential parameters.

7.4.4.2 Conclusions

Very Limited Data and Expert Opinion support the view that flicker can aggravate autistic behavior. Opinion exists on the nature or values of influential parameters or epidemiology of flicker sensitivity among the autistic population.

7.4.4.3 Low-Risk Level

No information available

7.4.5 Performance and asthenopia/eyestrain

From the beginnings of electric lighting to present times, flicker has been a source of complaints and associated with reduced performance on tasks. Research in this area appears to be divided into two categories: effects associated with visible or lower frequency flicker and effects associated with higher frequency or invisible flicker. Many researchers in the area of flicker consider this division to be somewhat artificial and naive, and the authors of IEEE Std 1789 are inclined to agree with this opinion. There is clear and abundant evidence that the upper frequency limit dividing visible and invisible flicker varies between individuals and that eye movement increases the upper frequency limit for flicker perception.

7.4.5.1 Visible flicker

As early as 1907, Sharp [B97] wrote that “It has been established as a result of practice that in general it is not possible to operate incandescent lamps on 25-cycle current with satisfactory results. This statement is made with knowledge of the fact that in certain cities a large amount of lighting is actually being done on 25-cycle circuits. Yet under some circumstances 25-cyclic current produces such marked flickering of incandescent lamps that its use is absolutely impossible.”

The question of the boundary between visible and invisible flicker, or critical flicker fusion frequency (CFF), has been studied extensively. Work in this area has been reviewed (for example) by Hart [B48] and Kelly [B63]. CFF depends on numerous factors in addition to flicker frequency, including stimulus intensity and size and location of retinal stimulation. It is also established that certain medical conditions affect CFF and that significant variation exists even within otherwise homogeneous population groups. Nevertheless, most researchers indicate a maximum value of at most 70 Hz or lower for the CFF under conditions most likely to create visible flicker. When the eyes and head are freely allowed to move, the CFF may be less reliable because a stroboscopic effect can be introduced by their relative motion.

Contrary to the majority of workers, Collins and Hopkinson [B22] and [B52] estimated that certain subpopulations might perceive 100 Hz flicker under certain lighting conditions. Their estimates are shown in Table 8.

**Table 8—Probability of flicker perception at 100 Hz
 (from Collins and Hopkinson [B22])**

Flicker index ¹¹ of waveform	Field luminance 50 ft-L (170 cd/m ²)	Field luminance 10 ft-L (34 cd/m ²)
0.1	1 in 150	< 1 in 10 000
0.2	1 in 33	< 1 in 10 000
0.3	1 in 14	< 1 in 10 000

In their recent study of SSL involving 10 volunteer subjects aged 23 to 55 years, Bullough et al. [B12] state that “Detection of flicker at 50 and 60 Hz was very high ($\geq 90\%$) and detection at frequencies of 100 Hz and higher was very low ($\leq 10\%$).” This is consistent with studies by Kelly [B65] that suggest CFF is between 50 Hz and 100 Hz for most individuals. Bullough et al. [B12] continue: “The results regarding the influence of flicker frequency on direct perception of flicker are entirely consistent with those of Kelly [B65]. At frequencies of 100 Hz and higher, perception of flicker while working on the laptop computer, while looking directly at the luminaire or while looking at an angular location remote from the luminaire, was negligible.”

There has been extensive work within UIE/IEC and IEEE to create flicker curves and a flickermeter that relate fluctuations in the voltage lines to noticeable (visible) flicker from incandescent lighting (see IEC 61000-4-15:2010 [B57], IEC 61000-3-3:2013 [B56], Cai et al. [B14] and [B15], Halpin et al. [B43], IEEE Std 1453™-2011 [B59], Halpin [B42], and Drapela and Slezinger [B29]). Subsequently, there is substantial data, theory, and analysis about how to determine the relationship between percent flicker, modulation depth, and the visibility of flicker. However, the flicker is characterized, in this IEC flickermeter approach, as the maximum allowable line ac voltage flicker at different frequencies before incandescent light flicker is noticed (see IEC 61000-4-15:2010 [B57], IEC 61000-3-3:2013 [B56], Cai et al. [B14] and [B15], Halpin et al. [B43], IEEE Std 1453-2011 [B59], Halpin [B42], and Drapela and Slezinger [B29]). Essentially, the line voltage flicker is isolated and then sent through filtering models that represent incandescent bulbs and the human-eye-brain interaction. After that, various frequencies are weighted and sent into a mathematical function (Pst) whose value should be kept below $Pst = 1$. With a value of Pst higher than 1, more than 50% of the viewers sense flicker. The approach is able to handle multiple subharmonics in complicated flickering waveforms. It is possible to use the same, widely accepted models of the IEC flickermeter and directly determine the amount of allowable *light* flicker before observers notice the flicker for flicker below 60 Hz. This is further explored in Clause 8.

In 1973, Brundrett [B10] undertook an extensive review of human sensitivity to flicker. Some highlights of his summary include the following:

- Zaccaria and Bitterman [B120] demonstrated that there was strong test subject preference to dc fluorescent lamps compared with those that use 60 Hz mains. However, later work (Brundrett et al. [B9]) could not replicate the same conclusions.
- Floyd [B36] did not discover significant partiality in office workers between the ac and dc office lighting.
- “The effect of multiphasing the lamps to minimize light fluctuations was examined by Segal¹², following earlier comparisons between incandescent and fluorescent lighting which favoured the former. Segal assumed that fatigue was related to the speed of identifying the correct orientation of a Landolt ring. He found that nine of his ten subjects fatigued more under single phase lighting than under the three phase operation.” (Brundrett [B10])
- Several researchers also discovered that multiphasing the lamps to produce lower light fluctuation levels seemed to lead to improved visual performance. Brundrett discusses, for example, that a large number of studies, however, on a small number of test subjects were performed by various researchers on fluorescent lamps operated on single-, two-, and three-phase electricity supplies. The various studies found that deterioration in visual performance was less under three- and two-phase

¹¹ Collins and Hopkinson [B22] use the flicker index of Eastman and Campbell [B30] defined earlier in this document.

¹² Full reference unavailable.

lighting than under single phase. However, visual performance was also heavily dependent on the duration of the visual work. In some studies there may have been small number of subjects that limited the sample size. Therefore, the importance of the amount of flicker versus the duration of visual work could not be conclusively determined.

- The well-known study of Rey and Rey [B89] describes a comparison of high-frequency lighting (100 000 Hz) and normal European 50 Hz operation. It was shown that for demanding clerical tasks, there was better performance with the high-frequency lighting, as measured by job accuracy and quicker response times.
- In a related study, Masakene [B75] considered the fatigue of workers in a factory functioning in a variety of industry applications. The research considered, again single phase, three phase, but also 1000 Hz flicker. The conclusions were that switching from single-phase to three-phase supply did not always lead to the reduced fatigue of the workers. However, altering to 1000 Hz lamp supply did.

Brundrett concluded his review with the following statement: “These results indicated that the flicker of fluorescent lamps could have a fatiguing effect on people, but the magnitude was small and could be dominated by the natural fatigue of the particular job.”

Brundrett also reviewed work by Kelly [B65] indicating that humans can perceive flicker with less than 1% modulation depth in the frequency range of 15 Hz to 25 Hz.

Brundrett conducted a survey of 600 people working in offices around the United Kingdom and found a positive correlation between those reporting headache and eyestrain and those reporting visible flicker. This was attributed to the introduction on 50 Hz flicker caused by excessive aging of the tube fluorescent lamps. “With normal fluorescent lamps (100 Hz modulation 20%–30%) the flicker which the occupants report is 50 Hz whole-tube fluctuations, usually caused by excessive ageing of the lamps.” Brundrett further comments that “Comparison of the lamp data with the subjective fusion results shows that the flicker which is normally seen in offices will be light modulation of 50 Hz. This confirms the study of Collins and Hopkinson.”

7.4.5.1.1 Influential parameters

Solid Data and Expert Opinion indicate that frequency and modulation depth are influential parameters for flicker visibility. Data exist on the maximum values of these parameters; however, these Data are derived under significantly different lighting conditions. Therefore, analysis or additional research will be needed to determine whether existing data are conflicting or in agreement. Data and Expert Opinion exist indicating duty cycle to be an influential parameter that is somewhat less important than modulation depth and frequency.

7.4.5.1.2 Conclusion

Solid Data and Expert Opinion indicate that any visible flicker causes asthenopia/eyestrain. Data to Solid Data and Expert Opinion indicate the nature and values of influential parameters. Solid Data and Expert Opinion indicate that flicker visibility and asthenopia/eyestrain vary widely among individuals. Studies cited above have not indicated susceptible subgroups; however, Expert Opinion indicates that older adults may be less susceptible due to reduced transmission of ocular media.

7.4.5.1.3 Low-Risk Level

Based on data of Kelly [B65] and Expert Opinion, frequency-independent Low-Risk Level modulation depth can be set to be below 1% for no effect. However, Figure 1 gives more specific Low-Risk Level and NOEL, which are as low as 0.3% modulation depth at very low frequencies. Based on work of Hopkinson and Collins [B52] and Roberts and Wilkins [B92], combined with the stroboscopic flickering acceptability levels previously discussed (Bullough et al. [B11]), Low-Risk Level modulation depth-independent upper

frequency is above 1250 Hz, while NOEL modulation depth-independent upper frequency limit is above 3000 Hz. More research is needed for a precise determination.

7.4.5.2 Invisible flicker

It is well established that flicker above the CFF can be detected in EEGs and electroretinograms (Berman et al. [B5]). A number of studies have indicated that invisible flicker can interfere with eye movements. A 1963 study by Rey and Rey [B89] found that performance on a proofreading task was better under high-frequency than low-frequency (100 Hz flicker) fluorescent lighting. In 1986, Wilkins [B112] directly measured effect of intermittent lighting from both fluorescent lights and video display terminals on extent of saccadic eye movement during reading using infrared eye tracking equipment. He found that flickering sources generally increase the extent of saccades by approximately the width of one letter. Wilkins et al. [B116] found in a study of office workers that switching from fluorescent lighting with significant 100 Hz flicker to lighting with a 32 kHz reduced-modulation ballast reduced average incidence of headache and eyestrain by over a factor of 2. In a study of 48 undergraduate students using 120 Hz ballasts and 20 kHz to 60 kHz reduced-modulation ballasts and three different types of lamp, Veitch and McColl [B107] found visual performance on a Landolt ring task to be significantly better under conditions of high-frequency flicker than low-frequency flicker. The results were corroborated in the recent paper by Jaen et al. [B61]. In a 1998 study involving 37 adult subjects performing reading tasks under low-frequency (100 Hz flicker) and high-frequency fluorescent lighting, Küller and Laike [B69] report that “The results of the subjective assessment of lighting quality showed that the light powered by conventional ballasts was perceived as less pleasant than the light powered by high-frequency ballast.” In addition, “when the light was powered by the conventional ballasts, individuals with high critical flicker fusion frequency (CFF) responded with a pronounced attenuation of EEG α waves, and an increase in speed and decrease in accuracy of performance.”

7.4.5.2.1 Influential parameters

Data and Expert Opinion indicate that frequency and modulation depth are influential parameters. Most studies compare magnetically ballasted fluorescent lights (100 Hz or 120 Hz) to lights operating at much higher frequencies (>20 000) with reduced-modulation electronic ballasts. Very Limited Data may exist for intermediate frequencies.

7.4.5.2.2 Conclusions

Data exist linking invisible flicker to asthenopia/eyestrain and decreased performance on certain tasks. Based on IEEE P1789 Working Group teleconferences, Expert Opinion appears to be divided. Studies cited above do not indicate potential susceptible subgroups.

7.4.5.2.3 Low-Risk Level

Expert Opinion was presented in IEEE P1789 Working Group teleconferences and Data. Roberts and Wilkins [B92] indicate 3000 Hz to be a modulation-depth-independent frequency NOEL. Expert Opinion and Data in IEEE Std 1789 indicates ~5% to be a frequency-independent modulation depth limit, at least for frequencies above those at which flicker is visible (Vogels et al. [B109]). Figure 18 illustrates low-risk limits and will be further explained in Clause 8.

7.4.6 Other effects

Other potential hazards have been associated with flicker, but have been the subject of relatively few studies. Risk was not assessed for these potential hazards.

7.4.6.1 Panic attack and anxiety

In a case report, Rosenblat [B93] describes a patient who “had a panic attack at work when a fluorescent light began flickering.” In another case report, Biddle and McCormack [B6] reported that “The younger female patient was so severely affected that she was hospitalized almost immediately because of her recurrent panic attacks. In the other two patients, the next attack occurred within a month and was in response to a sensory stimulus present at the initial reaction: in the case of the woman, when she was exposed to a flickering fluorescent light similar to the one in the doctor’s office....” Watts and Wilkins [B111] mention cases of panic attacks triggered by fluorescent lighting as well as increases in anxiety in agoraphobic patients exposed to fluorescent lighting with magnetic ballasts, and under double-masked conditions Hazell and Wilkins [B49] reported increases in heart rate among agoraphobics upon exposure to fluorescent lamps with 100 Hz flicker.

7.4.6.1.1 Influential parameters

Only a small amount of published information exists on this topic. Expert Opinion and Data indicate frequency and modulation depth to be influential parameters.

7.4.6.1.2 Conclusion

Data and Expert Opinion indicate that flicker might induce panic attacks and anxiety in certain subpopulations. No epidemiological data available.

7.4.6.1.3 Low-Risk Level

No information available

7.4.6.2 Flicker vertigo

Low-frequency (approximately 4 Hz to 20 Hz) flicker-induced dizziness or disorientation appears to be of significant concern among pilots (Rash [B87] and Masi et al. [B76]).

7.4.6.2.1 Influential parameters, conclusion, and Low-Risk Level

There appears to be Data to Solid Data and Expert Opinion on this phenomenon. It has not yet been reviewed or analyzed as relevance to IEEE Std 1789 is unclear.

7.5 Conclusion

This risk assessment covered the following potential adverse effects of flicker from lighting:

- Photoepilepsy or flashing-light induced seizure.
- Stroboscopic effect and associated apparent slowing or stoppage of rotating machinery.
- Migraine or severe paroxysmal headache often associated with nausea and visual disturbances.
- Increased repetitive behavior among persons with autism.
- Asthenopia, including eyestrain, fatigue, blurred vision, conventional headache, and decreased performance on sight-related tasks.

No characteristics of lighting other than flicker were addressed.

LEDs and LED-based lighting pose no inherent flicker hazard. LED lighting products with less flicker than commonly used incandescent, fluorescent, and compact fluorescent lamps (CFLs) are commercially available. However, flicker characteristics of LED (and other) lighting are determined primarily by power electronics, and LED lighting with higher modulation depth and flicker index than common incandescent, fluorescent, and CFLs have also been produced. This risk assessment covers the full range of possible

lighting flicker characteristics and is not weighted by the flicker characteristics of currently available LED lighting products. The latter was considered a poor predictor of future LED lighting flicker characteristics due to the rapidly changing nature of the LED lighting market. It is also the hope of the authors of IEEE Std 1789 to help design out potentially hazardous characteristics from future LED lighting products.

Probability and severity levels used in the risk assessment are defined in Table 4 and Table 5. The terms used to identify probability levels (very low, low, medium, high, and very high) and severity levels (mild, harmful, severe, and catastrophic) are common in risk assessments. Societal management of consumer product risk is a complex multifaceted process, as evidenced by the vast range of risk associated legally available products. This clause makes no conclusions regarding “acceptable” levels of risk.

The number of available studies varies greatly over the effects considered in this recommended practices document. Photosensitive seizure has been the subject of much more research than any of the other effects considered. The primary conclusion of this risk assessment is that more work is necessary to adequately understand the influence of flicker on migraine, autistic behavior, performance, and asthenopia/eyestrain and the characteristics of flicker that might lead to injury from stroboscopic effects.

The ranges of probability and severity for each of the effects are illustrated in Figure 16. The opacity of each shaded region represents the relative certainty associated with each probability/severity assessment. This technique is not common in risk assessment, but was introduced due to the significant differences in quantities and types of background information mentioned above.

8. Recommended practices¹³

Clause 7 extensively discussed the formal risk assessment and biological effects of flicker in lighting, and it is now possible to summarize several important conclusions:

- a) In the low-frequency range from ~1 Hz to ~65 Hz, the risk of photosensitive-epileptic seizures may be reduced if the percent flicker or modulation depth (Michelson contrast) is kept below 5%.
- b) It is possible to notice flicker during rapid eye movements (saccades) or with the stroboscopic effect at frequencies substantially above the CFF. During eye saccades, viewers may see a trail of lights (phantom array) with each rapid eye movement. In the stroboscopic effect, the object moves, and the eyes are not necessarily making a rapid movement. Based on three independent studies, for flicker frequencies above 90 Hz, a recommended no-effect region was derived to be $Mod\% < 0.0333 \times f$, where f is the frequency of the flickering light and $Mod\%$ is the modulation depth referring to the Michelson contrast. When this condition is satisfied, the phantom array effect may not occur.
- c) Similarly, a recommended low-risk region for flicker frequencies above 90 Hz is given by the line $Mod\% < 0.08 \times f$ and corresponds to a factor of about 2.5 above the recommended NOEL.
- d) A recommended low-risk region for frequencies below 90 Hz includes the region $Mod\% < 0.025 \times f$.
- e) The recommended no-effect region for flicker frequencies below 90 Hz may correspond to a factor of about 2.5 below the low-risk region, $Mod\% < 0.01 \times f$. These regions are illustrated in Figure 18.

This purpose of Clause 8 is to further explain these regions and present recommended practices derived from them. These discussions complement the extensive explanations given in Clause 7.

8.1 Recommended practices summary

Figure 20 summarizes the recommended operating area as a function of frequency and Modulation (%).

¹³ The authors of IEEE Std 1789 acknowledge that some lighting designers consider that applications, such as roadway lighting, in which there has been widespread acceptance of HID lamps, might not need restriction on flicker above 90 Hz.

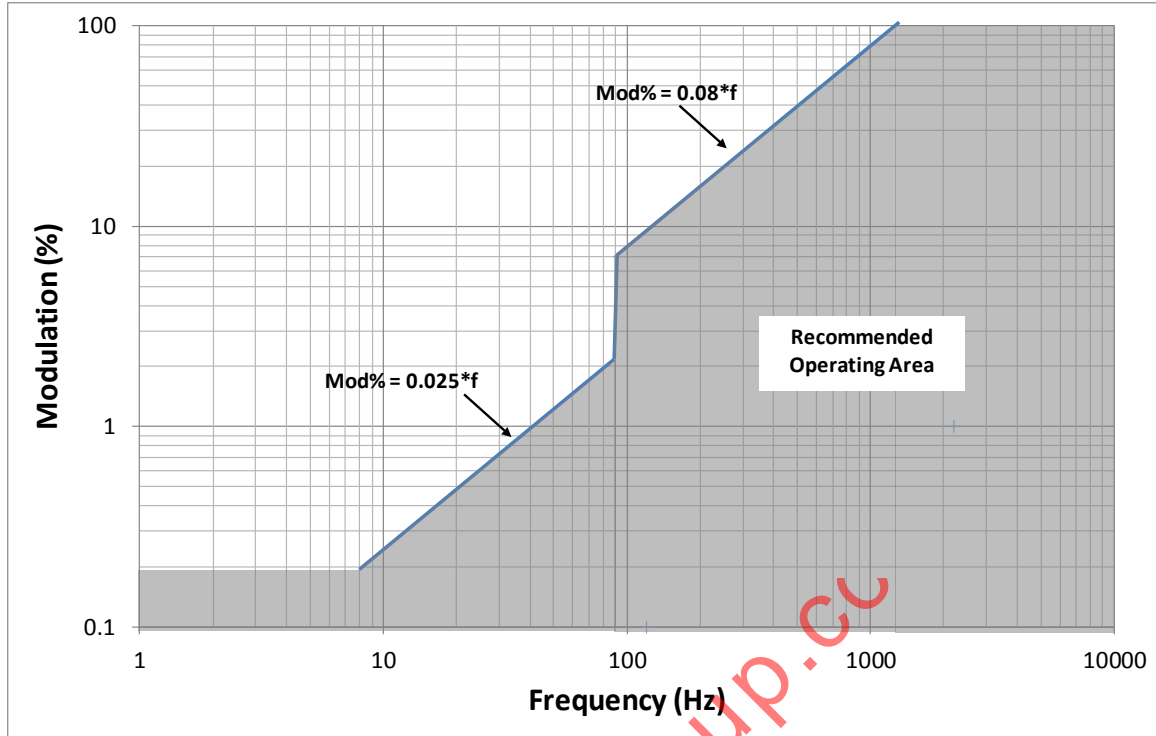

NOTE—Operating in the shaded area minimizes visual discomfort or annoyance and also gives low risk for headaches and photosensitive epileptic seizures. Below 90 Hz, Modulation (%) is less than 0.025×frequency. At or above 90 Hz, Modulation (%) is below 0.08×frequency. Modulation (%) = $100 \times (L_{max} - L_{min}) / (L_{max} + L_{min})$ where L_{max} , and L_{min} correspond to the maximum and minimum luminance, respectively. The figure was derived from the low-risk regions in Figure 18.

Figure 20—Recommended practices summary¹³

8.1.1 Simple recommended practices

Assume perfect ac power line conditions (purely sinusoidal with constant frequency and constant peak voltage). To limit the biological effects and detection of flicker in general illumination, then the Modulation (%) should be kept within the shaded region in Figure 20.

Specifically, define

$$\text{Modulation (\%)} = \text{Mod\%} = 100 \times (L_{max} - L_{min}) / (L_{max} + L_{min})$$

where L_{max} and L_{min} correspond to the maximum and minimum luminance, respectively. Then flicker Modulation (%) can be kept in the following regions for limited biological effects:

- **Recommended Practice 1:** If it is desired to limit the possible adverse biological effects of flicker, then flicker Modulation (%) should satisfy the following goals:
 - Below 90 Hz, Modulation (%) is less than 0.025×frequency.
 - Between 90 Hz and 1250 Hz, Modulation (%) is below 0.08×frequency.
 - Above 1250 Hz, there is no restriction on Modulation (%).

- **Recommended Practice 2:** If it is desired to operate within the recommended NOEL of flicker, then flicker Modulation (%) should be reduced by 2.5 times below the limited biological effect level given in Recommended Practice 1:
 - Below 90 Hz, Modulation (%) is less than $0.01 \times \text{frequency}$.
 - Between 90 Hz and 3000 Hz, Modulation (%) is below $0.0333 \times \text{frequency}$.
 - Above 3000 Hz, there is no restriction on Modulation (%).
- **Recommended Practice 3: (seizure prevention)** For any lighting source, under all operating scenarios, flicker Modulation (%) shall satisfy the following goal:
 - Below 90 Hz, Modulation (%) is less than 5%.

8.1.1.1 Comment 1

The recommended practices should be adhered to in all operating conditions, that is, in normal operation as well as failure modes, such as end-of-life scenarios, improper operation with dimmer switches, and all other operating circumstances. Furthermore, the authors of this document are unaware of widespread LED driving methods that insert harmonics below twice the line frequency, at least under normal operation. Therefore, it seems reasonable to give a general guideline to avoid flicker below 90 Hz whenever possible, in addition to Recommended Practice 2 and Recommended Practice 3.

8.1.1.2 Comment 2

As discussed in Clause 7, the distribution of light flicker characteristics among LED lights that will populate the future marketplace is unknown. There is no innate flicker hazard in LED lighting. However, it is assumed here that flicker characteristics of future LED lights could be uncontrolled and that nearly all of the U.S. population will be exposed to a potentially hazardous condition created by flicker at least once during a one-year timespan. Therefore, IEEE Std 1789 does not make application-specific recommended practices that are different for each lighting scenario.¹³ Instead, Recommended Practice 1 and Recommended Practice 2 begin with the phrase “If it is desired.” However, these important issues must be analyzed by lighting designers, and such issues are presented in 8.5. On the other hand, Recommended Practice 3 is a strict rule for seizure prevention and should be adhered to at all times for all operating conditions. This recommended practice does not begin with the phrase “If it is desired.”

8.1.1.3 Comment 3

The recommended practices describe the boundary functions of operation for the entire LED light source and not for the individual modulation of a single LED within the light source. It is well known that light can be phased and properly diffused so that the resultant total light source has a much lower net light output modulation. Alternatively, the flickering light source may be combined with daylight or other non-flickering sources to create lighting that flickers less.

8.1.2 Example calculations

Normally in lighting, the flicker frequency will have a fundamental component at twice the ac line frequency, i.e., $f_{\text{Flicker}} = 2 \times f_{\text{ac}}$ and that $f_{\text{Flicker}} > \text{CFF}$. Then, applying Figure 20 and the recommended practices, it is recommended that

$$\begin{aligned} \text{Mod}\% &< 0.08 \times f_{\text{Flicker}} \text{ for Low-Risk Level} \\ \text{Mod}\% &< 0.0333 \times f_{\text{Flicker}} \text{ for NOEL} \end{aligned}$$

8.1.2.1 Example 1: USA $f_{\text{ac}} = 60$ Hz

The Recommended Practice 1 for Low-Risk Level leads to Modulation (%) satisfying $\text{Mod}\% < 0.08 \times 120 \text{ Hz} = 10\%$ (rounded to the nearest percent).

The Recommended Practice 2 for NOEL leads to Modulation (%) satisfying $Mod\% < 0.0333 \times 120 \text{ Hz} = 4\%$ (rounded to the nearest percent).

8.1.2.2 Example 2: Europe $f_{ac} = 50 \text{ Hz}$

The Recommended Practice 1 for Low-Risk Level leads to Modulation (%) satisfying $Mod\% < 0.08 \times 100 \text{ Hz} = 8\%$ (rounded to the nearest percent).

The Recommended Practice 2 for NOEL leads to Modulation (%) satisfying $Mod\% < 0.0333 \times 100 \text{ Hz} = 3\%$ (rounded to the nearest percent).

8.1.2.3 Example 3: PWM dimming

Using Figure 20, the recommended practice for PWM dimming at 100% modulation depth is that the frequency satisfies $f > 1.25 \text{ kHz}$. This can also be derived using Recommended Practice 1 and solving $100\% = 0.08 \times f_{\text{Flicker}}$. This level of flicker could help minimize the visual distractions such as the phantom array effects.

The recommended NOEL for PWM dimming is 3 kHz, which can be seen in Figure 18 and can also be derived by using Recommended Practice 2 and solving $100\% = 0.03333 \times f_{\text{Flicker}}$.

8.2 Discussions about exposure duration

It is desirable to have a recommended practice that is independent of luminance, spectral content, and exposure duration. This is because it is never possible to fully know the application of particular lamp usages. By eliminating these parameters, a simpler recommended practice can be derived. This is further technically justified below.

8.2.1 Luminance

The perceptibility of flicker depends on its time-averaged luminance. At low luminance levels, high-frequency flicker is invisible. At scotopic light levels (dark-adapted vision), for example, flicker at 100% modulation depth is invisible above $\sim 5 \text{ Hz}$. At mesopic light levels (low but not dark lighting situations—a combination of scotopic and photopic vision), flicker at 100% modulation depth is invisible above $\sim 16 \text{ Hz}$ (Smith [B101]). (This may be one of several reasons why HID roadway lighting has received few complaints about flicker.) The CFF increases linearly with the logarithm of retinal illuminance over two log units from mesopic to photopic conditions (approximating 10 lux to 1000 lux with a 2 mm pupil) (Ferry-Porter law). The increase is log-linear for a wide range of modulation depths, although the slope decreases slightly at low modulation depths.

In particular patients with photosensitive epilepsy, the probability of paroxysmal EEG activity in response to patterns has been recorded as increasing approximately linearly with log luminance (Wilkins [B113]). It is therefore likely that with increasing illuminance any increase in risk will be linear with log illuminance. The slope of the increase is difficult to estimate, however.

It is known that 100 Hz flicker of nearly 100% modulation depth from low-pressure sodium (LPS) street lamps (low or mesopic illuminances) has not commonly been associated with complaints of headache, whereas fluorescent lighting in offices (photopic or high illuminance) has. It is also known that 48 Hz flicker at low luminances from cinema has not been associated with seizures whereas 50 Hz flicker at $\sim 200 \text{ cd/m}^2$ from television (CRT displays) most definitely has. This topic has been discussed in Clause 7 along with a corresponding hazard analysis and risk assessment.

It may thus be reasonable to conclude that low illuminances can help protect against the possible adverse effects of flicker. However, any light source (even a purportedly dim one) can provide a high retinal luminance under the appropriate viewing conditions, and viewing conditions are difficult to specify and control:

- It may therefore be more effective to design the flicker recommendations for a high illuminance source.
- It may be effective to ignore the actual illuminance provided by the flickering source and assume the source has high illuminance.

8.2.2 Spectral content

Given that a high illuminance white light source is assumed and that the luminance channel is known to have a higher CFF than associated color channels, it may be reasonable to assume that the photopic luminance function can be taken as adequately compensating for the spectral variation in human light sensitivity across the visible spectrum.

8.2.3 Exposure duration

In practice, there are few circumstances where exposure duration is readily controlled, except for perhaps the flashes that can occur during lamp ignition, and thus exposure should, in general, be regarded as being prolonged.

NOTE—Based on the above technical discussions, IEEE Std 1789 presents recommended practices regarding flicker that are independent of luminance, spectral content, or exposure duration.

8.3 Justifications for recommended practices¹⁴

In terms of perceived flicker, most of the past scientific and engineering studies have been primarily focused on flicker perception in conditions where gaze is directed at a particular visual scene or task. As Clause 7 explained, recent research (Roberts and Wilkins [B92]) has demonstrated that flicker perception during a saccade is related to a different retinal mechanism and that such perception during a saccade can occur at much higher temporal frequencies. Recent theoretical and experimental evaluations have supported this contention and have determined that frequencies as high as 3 kHz can be perceived. This kind of flicker perception has previously been reported in the vision literature and has been identified as phantom arrays. Thus both the two regimes of flicker perception, during steady viewing and during eye movement, should be included in recommended practices. Saccadic eye movement is a normal occurrence in interior environments, and such flicker perceptions associated with light sources may be as undesirable as any other type.

Below the conventional CFF of about 90 Hz, the amplitude of the Fourier fundamental should predict visibility (de Lange [B25]). For flicker during a saccade, the effects of the waveform are unknown, although Roberts and Wilkins [B92] have shown that the flicker is perceived as pattern. Assuming that this is the case, it is useful to apply Campbell and Robson's [B16] demonstration that the perception of a spatial pattern can be predicted from its Fourier components. The data are taken from the classic work of Kelly [B64] (diamonds) for visible flicker, from Bullough et al. [B11] (squares) and Perz et al. [B82] (circles) both for stroboscopic effects, and Roberts and Wilkins [B92] (triangles) for the intrasaccadic perception of phantom arrays.

Above 90 Hz flicker frequency, the approach of Lehman and Wilkins [B73] is taken. The NOEL can be derived using independently obtained data from Bullough et al. [B11] and Roberts and Wilkins [B92]. Roberts and Wilkins [B92] (triangles in Figure 18) measured the ability to see a flickering light during a saccade. They showed that during a saccade the flicker could be seen as a trail of lights even when the frequency of the flicker was as high as 2 kHz. The data from their paper [B92] were obtained when making horizontal saccades across a vertical bar that was either steady or intermittently illuminated (time-averaged luminance 150 cd/m²) in an otherwise dark room (<1 lux). On the basis of their perception of a phantom array, participants were forced to choose on which of two immediately successive trials the vertical bar was

¹⁴ Material from 8.3 for flicker frequencies above 90 Hz is taken from Lehman and Wilkins [B73].

intermittently illuminated. The forced choice procedure helped ensure veridical limits on perception that were not contaminated by a predisposition to report flicker when none was visible.

The data from Roberts and Wilkins [B92] were combined with those from other independent studies in which flicker was detected not as a direct result of eye movement but from movement of a target, i.e., the stroboscopic effect. First, the data from Bullough et al. [B11] (squares in Figure 18; data taken from their Figure 3) were combined with data from Perz et al. [B82] (circular points in Figure 18). In the study by Bullough et al. [B11], participants were asked to report the stroboscopic perception of a white rod they held in the hand and waved. The participants had the ability to alter the speed of the white rod until they noticed any flicker. The data in Figure 18 show the frequency at which flicker was reported on 50% of occasions. Perz et al. [B82] measured the stroboscopic flicker of a white dot on a black rotating turntable, revolving at a certain fixed speeds. Perz et al. [B82] asked observers to report the presence or absence of the stroboscopic effect, and a 50% threshold was obtained by increasing frequency in interleaved staircases with an initial dc standard for comparison. The data were those from the third of their experiments (their Figure 5), and the lowest modulation at which a stroboscopic effect was reported is shown. Despite the large differences in the methods and measures used in the above studies, the data set had a broadly similar slope when plotted on log-log coordinates (see Figure 18). The mean regression through the entire data set had a slope similar to that of a line $Mod\% = 0.0333 \times f_{Flicker}$. The intercept of the line that divides the no-effect region from the low-risk region was selected so that most of the data lay above the line (as is appropriate for a no-effect region). The few data below the line can be justified in that they were obtained without control for the “false positive” reporting of flicker.

The low-risk region $Mod\% \leq 0.08 \times f_{Flicker}$ was then derived by multiplying the NOEL line by a factor of 2.5.

The conservatism of the low-risk region is explored later in this clause.

8.3.1 Below 90 Hz flicker frequency

There has been extensive work within IEC 61000-4-15:2010 [B57], IEC 61000-3-3:2013 [B56], and IEEE Std 1453-2011 [B59] to create flicker curves and a flickermeter that relate fluctuations in the voltage lines to noticeable flicker from incandescent lighting (Cai et al. [B14] and [B15], Halpin et al. [B43], Halpin [B42], and Drapela and Slezinger [B29]). Subsequently, there is substantial data, theory, and analysis about how to determine the relationship between percent flicker, modulation depth, and visibility of flicker when below the CFF. The flicker is characterized, in this IEC flickermeter approach, as the maximum allowable line ac voltage flicker at different frequencies before incandescent light flicker is noticed (IEC 61000-4-15:2010 [B57], IEC 61000-3-3:2013 [B56], Cai et al. [B14] and [B15], and Halpin et al. [B43]). Essentially, the line voltage flicker is isolated and then sent through filtering models that represent incandescent bulbs and the human-eye-brain interaction. After that, various frequencies are weighted and sent into a mathematical function (Pst) whose value should be kept below $Pst = 1$. With a value of Pst higher than 1, more than 50% of the viewers sense flicker. The approach is able to handle multiple subharmonics in complicated flickering waveforms because it weights the harmonics appropriately. A value of Pst above 1 is considered unacceptable. The calculation of the function Pst is too complex to describe in this recommended practices document, but is well explained in IEC 61000-4-15:2010 [B57], IEC 61000-3-3:2013 [B56], Cai et al. [B14] and [B15], and Halpin et al. [B43].

For flicker below 60 Hz, it is possible to use these same, widely accepted models of the IEC flickermeter and directly determine the amount of *light* flicker allowable before observers notice the flicker. In fact, the model of the light bulb can be eliminated in the simulations, and the relation between the function Pst and light flicker becomes readily established (instead of voltage line fluctuations). Furthermore, it is also possible to characterize the internal light flicker signals through the models and plot the acceptable light Modulation (%) for the value of $Pst = 1$. Here, the simulation approaches of Drapela and Slezinger [B29] are used while assuming an equivalent standard 60 W incandescent lamp and average observer eye-brain response employed in the standardized IEC flickermeter. Then the resulting figure is related to the observing conditions for which the limiting curve was determined (the test points are published in IEC 61000-4-15:2010 [B57], and the curve itself can be seen in IEC 61000-3-3:2013 [B56]).

Notice that the curve in Figure 21 is approximately linear in the region of $8\text{ Hz} < f < 33\text{ Hz}$, which is where, in particular, the eye is most sensitive to flicker. This corresponds well with the low-frequency data plotted in Figure 18 from Kelly [B64] (diamonds) for visible flicker. In fact, it is possible to superimpose the Low-Risk Level line introduced in Figure 20 over the curve in Figure 21 to see how the graphs agree with each other in this region.

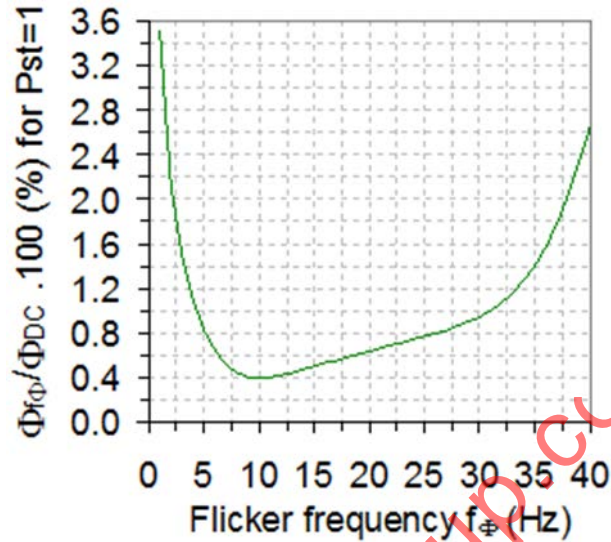

Figure 21—Simulation of Modulation (%) of light flicker versus flicker frequency for IEC flickermeter acceptability with $P_{st} = 1$ (Below the green curve implies that the flicker is not visible.)

Figure 22 indicates that at low frequencies, maintaining $Mod\% < 0.025 \times \text{frequency}$ may be lower risk and gives a region below the IEC flicker curve. The line becomes more conservative as the flicker frequency is increased above 35 Hz. In the ranges of flicker frequency between 10 Hz and 30 Hz, though, the recommended practice line and the IEC flicker curve are within 0.2% modulation depth, which may even be within measurement error. Therefore, they give consistent results. However, it is important to remember that this is also a potentially hazardous region and contains the flicker frequencies that may trigger epileptic seizures for a small percentage of individuals (see Clause 7). Furthermore, the authors of this document are unaware of widespread LED driving methods that insert harmonics below twice the line frequency, at least under normal operation. Therefore, it seems reasonable to utilize this same line, $Modulation (\%) < 0.025 \times \text{frequency}$ for the recommended practice at frequencies below 90 Hz, which maintains the recommended practice region at lower potential risk than the IEC curve at all flicker frequencies. It follows that half-bridge rectifiers should not be used directly to drive LED strings because they will produce 100% modulation depth at flicker frequency equal to the line frequency (e.g., 60 Hz or 50 Hz). This may induce the photosensitive seizures in susceptible people.

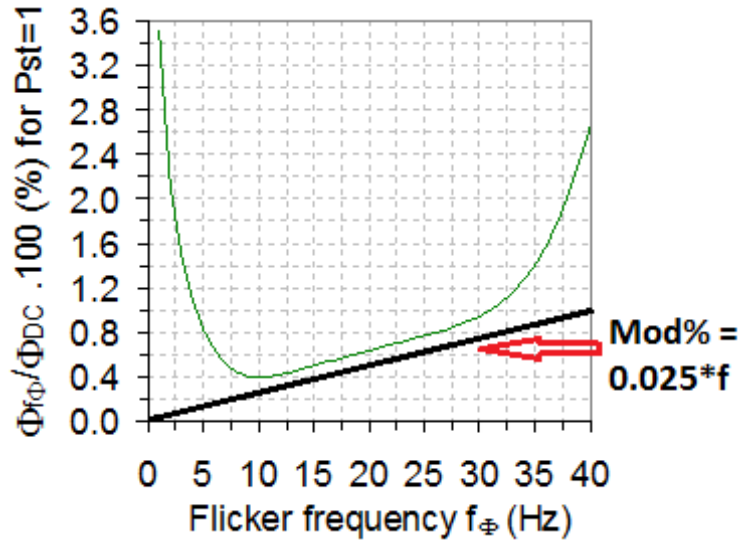

Figure 22—Recommended practice line $Mod\% = 0.025 \cdot f$ and IEC flickermeter curve in low-frequency ranges

8.3.2 Above 90 Hz flicker frequency

For flicker frequencies above 90 Hz, there is less sensitivity to the light flicker and less certainty about the acceptable limits. Although it might be desirable to maintain the modulation well within the no-effect region given in Figure 18, it might be unreasonable to do so, given that incandescent lighting is generally acceptable and yet can exhibit 10% modulation depth at 120 Hz. The authors of IEEE Std 1789 have therefore taken the pragmatic view that at frequencies above 90 Hz the upper limit of modulation should be 2.5 times the NOEL (i.e., Modulation (%) = $0.08 \cdot \text{frequency}$). This explains the discontinuous jump in Figure 20 at 90 Hz. That is, from 35 Hz to 90 Hz, a conservative low-risk region is recommended, but above 90 Hz, a less conservative region is proposed. The degree of conservatism of the line Modulation (%) < $0.08 \cdot \text{frequency}$ is not known, although there is consensus among the authors of this document that this contains the low-risk region.

It is possible to comment on both the detection and acceptability of the flicker when the recommended practice is followed. According to either Roberts and Wilkins [B92] or Bullough et al. [B11], it is possible to create worst-case experiments in which the flicker will be detectable from either eye saccade or simple stroboscopic experiments, even when Recommended Practice 1 is maintained above frequencies of 90 Hz. Therefore, it is known that there might be circumstances when the flicker becomes perceivable when the criterion $Mod\% < 0.08 \cdot f$ is satisfied. However, under normal photopic lighting conditions, it is likely not to be detected; therefore, it is believed that this remains a low-risk region.

The studies above regarding stroboscopic effects and eye saccades are based on a limited number of laboratory studies. However, DOE/PNNL measured the detection of flicker in LED troffers in real world lighting situations. According to recent DOE/PNNL studies (Poplawski and Miller [B83] and Miller et al. [B77]), some individuals noticed flicker in various commercial LED lamps. A total of 18 observers were asked to evaluate flicker from LED luminaires in a mockup office space. The observers used a four-point scale:

- 1 = Bad flicker
- 2 = Moderate flicker
- 3 = Almost no flicker
- 4 = No flicker perceived

A total of 21 LED lamps were tested. If the lamp had dimming capabilities, then it was tested at full output and when dimmed. At full output, none of the observers were able to reliably detect flicker, even when percent modulation reached ~24%. However, when dimmed, some of the lamps had flicker that was noticeable either by stroboscopic effect (produced by hand motion or pencil movement in the troffer area) or with normal eye motion only. The study suggests that a rating of perceived flicker of 2.6 represents the borderline low to moderate flicker and that values below this might lead to observer distractions. Table 9 shows the lamps that had ratings below this value.

Table 9—Data points from DOE/PNNL CALiPER study (Miller et al. [B77]) for dimmed LED luminaires that were considered to have detectable (low to bad) flicker in office

Lamp (dimmed)	Flicker rating	Modulation (%)	Approximate flicker frequency (Hz)
M	2.56	100%	480
L	2.44	16.3%	120
N	2.22	13.2%	120
U	2.22	55.7%	120
X	1.50	100%	250
G	1.39	100%	260
E	1.28	100%	270

Several points should be noted from the DOE study and data in Table 9 (Lehman and Wilkins [B73]):

- Each of the luminaires listed in Table 9 with flicker rating < 2.6 would violate the Recommended Practice 1 condition that $Mod\% < 0.08 \times f_{Flicker}$.
- All 21 luminaires that satisfied the condition $Mod\% < 0.08 \times f_{Flicker}$ had a flicker rating above 2.6, whether dimmed or not.
- Two LED luminaires at full output and one at dimmed level did not satisfy the condition that $Mod\% < 0.08 \times f_{Flicker}$, yet they had a flicker rating above 2.6; this result suggested that in the conditions tested, the flicker was not regularly detected.

Based on the three points above, it can be inferred that for flicker frequencies above 90 Hz, the Recommended Practice 1 condition that $Mod\% < 0.08 \times f_{Flicker}$ should contain the low-risk level, but with proper design of specific lighting circumstances (e.g., glare, brightness, spectral content), it may be possible to operate outside the region and still be acceptable. However, for a condition that contains only frequency and $Mod\%$, without other parameters, the DOE/PNNL experiments seem to support that Recommended Practice 1 is not overly conservative. In fact, Lamp N with 13.2% flicker modulation depth at 120 Hz created a low flicker rating. As Example 1 suggested (see 8.1.2.1), Recommended Practice 1 would create a limit of 10% modulation depth at 120 Hz, and this value is not much lower than the measured 13.2% flicker.

In a separate and independent recent study (Bullough et al. [B11]) of the detectability and acceptability of flicker in lamps, it was shown that stroboscopic effects from flicker may be detectable but at the same time they may also be acceptable, at least for the very short-term exposure that was studied. A five-point scale was introduced to assess the acceptability among subjects screened to exclude those with migraines or epileptic seizures:

- +2 very acceptable
- +1 somewhat acceptable
- 0 neither acceptable nor unacceptable
- -1 somewhat unacceptable
- -2 very unacceptable

Formulas were derived to model an estimated acceptability value in relation to flicker frequency and Modulation (%). Using these formulas, the authors of IEEE Std 1789 simulated the acceptability rating of lines $Mod\% = 0.0333 \times f$ (no effect) and $Mod\% = 0.08 \times f$ (low risk). These results are shown in Figure 23.

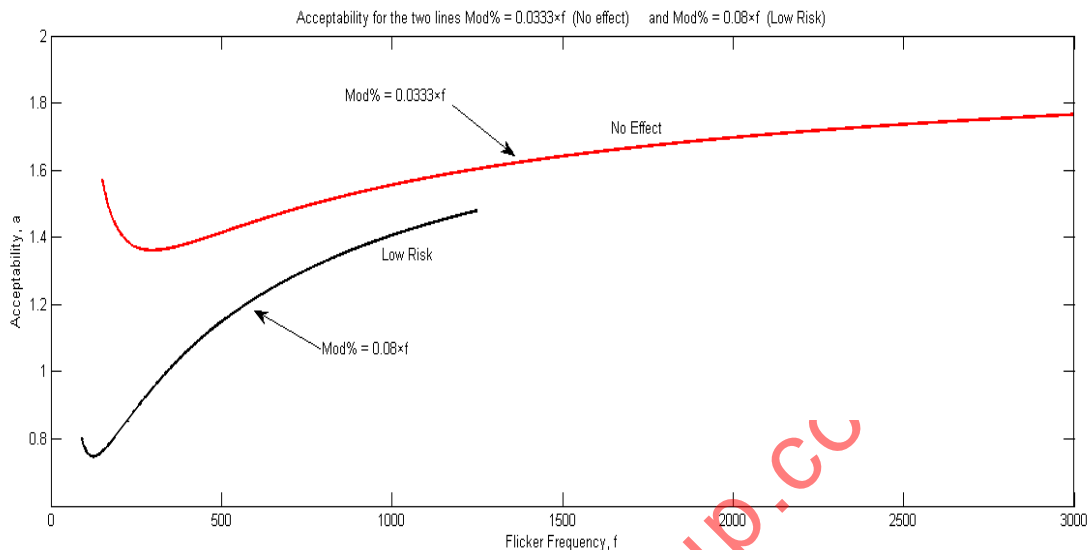

NOTE—Rating the acceptability parameter, a , of Bullough et al. [B11] for (a) the low-risk line $Mod\% = 0.08 \times f$ with flicker frequencies in the range $90 \text{ Hz} < f < 1250 \text{ Hz}$ and (b) the NOEL line $Mod\% = 0.0333 \times f$ with flicker frequencies in the range $150 \text{ Hz} < f < 3000 \text{ Hz}$. An acceptability score of 0 indicates neither acceptable nor unacceptable. A score of +1 indicates somewhat acceptable, and a score of +2 is very acceptable.

Figure 23—Rating the acceptability

As shown in Figure 23, the NOEL line ($Mod\% = 0.0333 \times f$ when $f > 90 \text{ Hz}$) always has acceptability between ~ 1.4 and ~ 1.8 , i.e., it is close to being in the “very acceptable” category at all times. The low-risk line ($Mod\% = 0.08 \times f$ when $f > 90 \text{ Hz}$) has acceptability values between ~ 0.75 and ~ 1.5 . It has minimum value (~ 0.75) at 120 Hz, which is the frequency at which many LED lamps flicker when there is 60 Hz ac power. Thus, at 120 Hz, the stroboscopic effect is rated on this scale as being between “neither acceptable nor unacceptable” and “somewhat acceptable.” This indicates that the region $Mod\% < 0.08 \times f$ may not be overly conservative, at least at 120 Hz flicker. (The approaches of Bullough et al. [B11] are applicable only when $Mod\% > 5\%$; therefore, it is not possible to calculate the acceptability rating for flicker frequencies below 90 Hz in the recommended practice regions.)

8.4 Subharmonics at line frequency

Subharmonics below the fundamental frequency may be of concern because they are normally in the range of frequencies that may cause a risk of photosensitive epileptic seizures in susceptible individual. Clause 5 gave examples of how aging or failure in certain types of driving methods for LEDs (the ac LED driving method) may cause a noticeable harmonic component at line frequency. In the United States, this would be at 60 Hz, and in Europe this would occur at 50 Hz. Clause 7 performs the hazard analysis and risk assessment that caution about seizures from this flicker.

Once again, since the authors of IEEE Std 1789 were unaware of normally functioning commercial LED drivers that cause flicker below 90 Hz, it should be possible for most lamps to avoid flicker in this lower frequency range. This would prohibit ac single-phase half wave rectification to directly drive LED strings. More importantly, line frequency harmonics can occur in failure modes, and this should be prevented.

Figure 24 illustrates again what happens when the light output from each half cycle of a 60 Hz supply is not balanced, perhaps because of some partial rectification. As Clause 5 mentioned, for example, full-wave rectification failure may cause a measurable harmonic component of flicker at line frequency in LED driving circuits.

The recommended operating area of Figure 20 was derived assuming no subharmonics or interharmonics. There is ongoing research on how to weight the harmonic components in the Fourier series that includes subharmonic and interharmonic frequencies. For low frequencies (<35 Hz to 40 Hz), the authors of IEEE Std 1453-2011 [B59], IEC 61000-4-15:2010 [B57], and IEC 61000-3-3:2013 [B56] are beginning to look at LED lamp flicker and plan in the future to write specifications about this subject in particular for LED lamp flicker due to voltage flicker. However, the IEC flickermeter remains applicable to the low-frequency component; therefore, the Pst value approach could be carefully applied.

The following ideas (not a recommended practice) might prove helpful to lamp designers who are concerned about subharmonics and interharmonics causing detectable flicker:

- a) Recommended Practice 1 (or 2) and Recommended Practice 3 should be followed.
- b) All harmonic components of a signal should lie within the low-risk area in Figure 20.
- c) It might be possible to inversely weight the different harmonic components according to the lines $Mod\% = 0.025 \times f$ when the harmonic frequency is below 90 Hz or $Mod\% = 0.08 \times f$ when the harmonic frequency is above 90 Hz. (A similar approach could be applied to Recommended Practice 2 if the recommended NOELs are desired.)

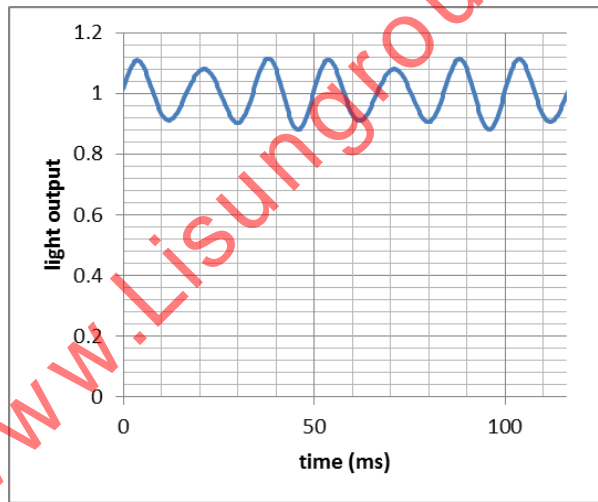

Figure 24—Periodic flicker with 60 Hz and 120 Hz frequency components

Specifically, a digital oscilloscope or spectrum analyzer may be used to perform a Fast Fourier transform of the signal, deriving the Fourier series coefficients, c_1, c_2, c_3, \dots , of the periodic light output. For the purpose of illustration, assume that the light output signal, $x(t)$, is periodic with period $T = 1/f$ where f is the fundamental frequency of the signal. Defining $\omega = 2\pi f$, the signal may be represented by the Fourier series

$$x(t) = X_{avg} + \sum_{m=1}^{\infty} c_m \cos(2\pi f_m t + \phi_m)$$

where X_{avg} is the average value of $x(t)$, c_m are the Fourier amplitude coefficients corresponding to frequency f_m , and ϕ_m represents the angular phase shift for this frequency. Without loss of generality, it can be assumed that f_m is an increasing sequence. Therefore, the following steps may be performed:

Step 1: Truncate the Fourier series so that the highest frequency is below 1250 Hz. This will leave a countable, N , number of harmonic components.

$$X_{trunc}(t) = X_{avg} + \sum_{m=1}^N c_m \cos(2\pi f_m t + \phi_m)$$

where by design, $f_N < 1250$ Hz.

Step 2: Weight each harmonic coefficient, c_m , by a scaling factor.

$$\tilde{X}_{trunc}(t) = X_{avg} + \sum_{m=1}^N \tilde{c}_m \cos(2\pi f_m t + \phi_m)$$

where

$$\tilde{c}_m = \begin{cases} \frac{4000 |c_m|}{f_m} & \text{when } f_m < 90 \text{ Hz} \\ \frac{1250 |c_m|}{f_m} & \text{when } 90 \text{ Hz} < f_m < 1250 \text{ Hz} \end{cases}$$

Step 3: Compute the normalized modulation, defined by the variable NM , as

$$NM = \sum_{m=1}^N \left(\frac{\tilde{c}_m}{X_{avg}} \right) < 1$$

where a value of $NM < 1$ is an acceptable level of flicker.

Regarding the weighting function in Step 2, the weighting of the Fourier coefficients is directly derived from the low-risk level lines $Mod\% = 0.025 \times f$ or $Mod\% = 0.08 \times f$. For example, above 90 Hz, the acceptable $Mod\% = 0.08 \times f$. Therefore, the Modulation (not in %) is given as $Mod = 0.0008 \times f$. Therefore, the Fourier coefficient would be weighted by $1/Mod = 1250/f_m$ in Step 2 when the frequency of interest is above 90 Hz. Similarly, for below 90 Hz, the weighting would become $1/Mod$ where $Mod = 0.00025 \times f_m$. Therefore, when there exists only a single harmonic, the condition $NM < 1$ becomes equivalent to Recommended Practice 1.

8.4.1 Example 4: Single subharmonic

Under normal operation, the dominant frequency of the flicker will be at twice the line frequency, where line frequency f_{ac} is often 50 Hz or 60 Hz. Then the flicker frequency, $f = f_{Flicker} = 2 \times f_{ac}$ is normally 100 Hz or 120 Hz; therefore, $f_{Flicker} > 90$ Hz. However, suppose that there is a single subharmonic at f_{ac} , which is at half the dominant frequency. Then the light output has a component at half the dominant frequency and twice the original flicker period, as in Figure 24. Unfortunately, as Clause 5 described, this type of waveform is possible if certain types of driving schemes are used and the LED strings become unbalanced. Figure 24 shows an extreme case.

For this example, supposing that $f_{ac} = 50$ Hz and that there are only two harmonics, $x(t) = X_{trunc}(t)$ can be written:

$$x(t) = X_{trunc}(t) = X_{avg} + c_1 \cos(2\pi(50)t + \phi_1) + c_2 \cos(2\pi(100)t + \phi_2)$$

For the purpose of illustration only, assume that $X_{avg} = 1$, $c_1 = 0.005$, and $c_2 = 0.06$.

Using Step 2, the weighted Fourier coefficients are computed to become

$$\begin{aligned}\tilde{c}_1 &= (4000 \times 0.005) / 50 = 0.4 \\ \tilde{c}_2 &= (1250 \times 0.06) / 100 = 0.75\end{aligned}$$

Finally, the normalized modulation (NM) can be calculated as

$$NM = \sum_{m=1}^2 \left(\frac{\tilde{c}_m}{X_{avg}} \right) = \frac{0.4}{1} + \frac{0.75}{1} = 1.15 > 1$$

Since $NM > 1$, the flicker could be a distraction. This is true even though the individual components of flicker lie within the shaded region in Figure 20: Specifically, the Modulation (%) due to the 50 Hz component is 0.5%, and this is less than the low-risk level of Modulation (%) being $0.025 \times 50 = 1.25\%$. Similarly, the 100 Hz component composes only 6% modulation depth, where its individual limit would have been 8%. This is a case, however, where the normalized sum (NM) is greater than 1.

The above approach is open to further improvements and is meant only as a suggestion if a designer is interested in possible approaches to minimize risks due to subharmonics. It represents one possible approach to adapt Figure 20 to apply to more complicated waveforms. For example, a similar approach has been proposed by Perz et al. [B82]. The Fourier coefficient is weighted according to the stroboscopic threshold at the specific frequency. Then a special Minkowski norm (with $n = 3.7$) is introduced to create a score, similar to the one proposed in this recommended practices document. In fact, the approach by Perz et al. [B82] and the three-step approach above become quite similar if the Minkowski norm is taken with $n = 1$ instead of $n = 3$. Furthermore, the work of Lehman et al. [B71] and [B72] suggests other norms and metrics that may be suitable for flicker.

8.4.2 Important final comments

LED luminaire light outputs with subharmonic or interharmonic components below twice the line frequency should not be designed. Harmonics below 90 Hz should be avoided (assuming perfect ac line) if possible.

8.5 Final comments on recommend practice

This recommended practices document proposes the $Mod\%$ versus flicker frequency regions in which the risk of distraction and possible adverse health effects of flicker may be lower. Earlier clauses make it clear, however, that flicker health risk is highly dependent on a variety of lighting application and exposure factors. Turning to historical precedent, HPS lamps on magnetic ballasts have been reported to have 84% modulation depth, and LPS lamps sometimes have nearly 100% modulation depth. These are both at 100 Hz or 120 Hz and have been used without widespread complaints about flicker for almost 50 years in many applications, such as outdoor lighting, greenhouse lighting, etc. According to DOE/PNNL researchers (Poplawski and Miller [B83]), a lighting situation may determine the case-by-case tolerance of flicker. They conjecture that flicker matters most in general lighting, spaces where children or susceptible populations spend time, task lighting, and industrial spaces with moving machinery. It is possible, they suggest, that flicker could be less problematic in possible applications such as parking lots and roadways. However, even in these instances, they indicate that prudence should be used. Furthermore, the risk analysis in Clause 7 clearly demonstrated that it is not possible to guarantee items such as length of exposure to a ubiquitous light source, even, for example, roadway lighting—given the millions of people that will be exposed to them. Therefore, IEEE Std 1789 does not provide application-specific recommended practices but, instead, gives recommended practices that can be used to help mitigate the risk of possible adverse biological health effects in all types of LED lighting. This was the scope/charter of the IEEE working group. In general, specific lighting application issues are outside the scope of IEEE but in the scope of other organizations and standards groups, such as CIE, IEA 4E Solid State Lighting group,

ISO TC 274, ENERGY STAR, CALiPER, etc. The logical next step would be for these bodies to work with this document to develop application-specific recommendations that can weigh such matters as adaptation luminance, color, tasks, etc.

Prior to IEEE Std 1789, the issue of flicker in LED lighting was not well known. This recommended practices document attempts to provide as much information to the reader (e.g., ballast designers, other standards or certification organizations) about the best knowledge available at the present time to help minimize the risk of distraction and possible adverse biological effects of flicker in LED lighting. At minimum, designers may decide to use this information to help design the output filters or switching frequency of their driving methods for LED lamps. The authors of IEEE Std 1789 recognize, also, for example, that it is common in the video game industry to put warning labels in their products/manuals to alert photosensitive people about their products if they believe flicker is a concern. See Clause 7 about risk tolerance for further discussions on similar issues. It is up to the community and other standards organizations to determine how to best use the information in this document. Additionally, the authors of this document urge the industry to continue to critically evaluate data from research and from field experience and make additional recommendations when supported by data.

www.Lisungroup.cc

Annex A

(informative)

Glossary

This glossary gives only short definitions, and the reader is referred to IES's *The Lighting Handbook* [B28] or CIE S 017/E:2011 [B21] for further explanations.

cones: Photoreceptor cells in the retina responsible for the process of photopic vision.

critical flicker fusion frequency (CFF): Also known as fusion frequency, critical flicker fusion, or critical flicker frequency. Threshold frequency at which a flickering light is indistinguishable from a steady, non-flickering light. An alternate definition is given by CIE as “the frequency of alternation of stimuli above which flicker is not perceptible” (CIE S 017/E:2011 [B21]).

depth of modulation: *See: percent flicker.*

dimming range of LEDs: The range of possible lumen output for a given LED, usually expressed as a percentage of maximum lumen output. For example, a system may be able to “dim to 10%.” Techniques such as pulse width modulation (PWM) are commonly used for LED dimming, as described in this document.

flicker: A change in the luminous flux of a lamp or illuminant due to fluctuations in the voltage of the power supply (*Lighting Handbook* [B28]). This definition uses the IES terminology that has been adapted by Poplawski et al. [B84] and Wilkins et al. [B117]. The definition can be categorized into “visible flicker” and “invisible flicker” to clarify the CIE definition of flicker (CIE S 017/E:2011 [B21]). *See also: invisible flicker and visible flicker.*

flicker index: Referring to Figure 1, the area above the line of average light divided by the total area of the light output curve for a single cycle.

$$\text{Flicker Index} = (\text{Area 1}) / (\text{Area 1} + \text{Area 2})$$

high-brightness LEDs: High-power LEDs with current consumption on the order of hundreds of milliamps. A single high-brightness LED can be used to replace a single incandescent bulb. The efficiency of these LEDs can exceed 100 lm/W. The efficiency of a typical incandescent bulb is in the 15 lm/W range.

invisible flicker: A temporal instability in illumination (flicker) above the critical flicker fusion frequency (CFF). Note that flicker involves variation in luminance over time. The perception of flicker therefore involves an awareness of the temporal variation in intensity. There is no such awareness above CFF, and it is therefore appropriate to refer to it as “invisible” flicker. Above CFF, the flicker is appreciated only in terms of its effects on spatial perception, such as the phantom array or the stroboscopic effect. However, even without observer awareness of invisible flicker, there may be biological neuron response from the invisible flicker (Poplawski et al. [B84] and Wilkins et al. [B117]).

long-term exposure: A two-hour exposure to flicker. Long-term flicker, Plt, is calculated from the cubic average of 12 short-term flicker (Pst) values. According to IEC 61000-3-3:2013 [B56], Plt is not to exceed 0.65. *See also: flicker and short-term exposure.*

mesopic adaptation: The adaptation of the eye to vision in low-light situations. Mesopic vision is between scotopic vision and photopic vision. Both rods and cones are active.

Michelson contrast: *See: percent flicker.*

modulation depth, modulation percentage, Modulation (%), or Mod%: *See: percent flicker.*

ocular motor control: A term that refers generically to all the motor systems of the eye, including the neural system that controls eye lid closure, the amount of light that enters the eye, the refractive properties of the eye, and eye movements.

P_{lt}: A function defined by IEC 61000-4-15:2010 [B57] and IEC 61000-3-3:2013 [B56] to represent long-term flicker severity.

P_{st}: A function defined by IEC 61000-4-15:2010 [B57] and IEC 61000-3-3:2013 [B56] to represent short-term flicker severity. Evaluation time is normally 10 min, unless otherwise specified.

peak-to-peak contrast: *See: percent flicker.*

percent flicker: Also known as peak-to-peak contrast, Michelson contrast, Modulation (%), or modulation depth. Referring to Figure 1, a term defined as follows:

Percent Flicker or equivalently Modulation (%)

$$Mod\% = 100 (Max - Min)/(Max + Min) = 100 (A - B)/(A + B)$$

The variable *Mod%* represents the value of Modulation (%), and this variable is often used in formulas. Sometimes when specifying a certain percentage value of Modulation (%), it is written as, for example, 75% modulation depth.

perception (or visual perception): The interpretation of visual sensation.

phantom array: The appearance of multiple images of objects lit with a temporally unstable light source as a result of eye movement.

photosensitive seizures: A form of epilepsy in which seizures are triggered by visual stimuli that form patterns in time or space, such as flashing lights; bold, regular patterns; or regular moving patterns.

photopic adaptation: The normal state of adaptation of the eye under well-lit conditions of luminance levels $> 5 \text{ cd/m}^2$. The cones are the primarily utilized photoreceptors.

saccade: Abrupt, rapid, small movements of both eyes in the same direction, such as when the eyes scan a line of print. Saccades occur automatically, serving to project the scene to different parts of the retina in order to build a complete image with no blind spot. The saccades can be divided into two distinct groups: the major saccades that are easily observed with the naked eye and the minor saccades that are virtually unobservable without special instrumentation.

scotopic adaptation: The adaptation of the eye to vision under low light conditions by pupil dilation and increased sensitivity of the retina (to luminance $< \sim 10^{-3} \text{ cd m}^{-2}$). Rod photoreceptors are active in scotopic vision, and there is no color perception.

sensation of flicker: The eye/brain/neurological system detects the modulation of light output over time in the external conditions, and neurons respond. The observer may be aware or unaware of the unsteadiness of light, but the neurons may still respond.

short-term exposure: A 10-minute exposure to flicker. Short-term flicker, P_{st}, is measured by applying a specific statistical process to a 10-minute sample of flicker data. According to IEC 61000-3-3:2013 [B56], P_{st} is not to exceed 1.0. A P_{st} of 1.0 means that about 50% of individuals will perceive flicker in this interval. *See also: flicker.*

spectral power distribution: Power per unit area per unit wavelength of a light source. Different light sources have different spectral power distributions. (For instance, incandescent lamps tend to have more power in the yellow to red region compared to fluorescent lamps. LED lighting with white light has a wide variety of spectral power distributions depending on the approach used to create the white light with the LEDs.)

stroboscopic effect: The appearance of multiple, discrete images of moving objects as a result of temporally unstable illumination. The effect may also change the appearance of the objects in their motion.

upper spatial frequency: The limit of spatial frequency at which perception of the variation of a luminescent signal is impossible, where spatial frequency is the number of cycles per degree subtended by the eye.

visible flicker: The appearance of a temporal instability in illumination due to flicker (Wilkins et al. [B117]). This corresponds to the CIE's definition of flicker, which is given as "the impression of unsteadiness of visual sensation induced by a light stimulus whose luminance or spectral distribution fluctuates with time" (CIE S 017/E:2011 [B21]) (provided that neither the eye is making a saccade nor the object being illuminated is in motion).

www.Lisungroup.cc

Annex B

(informative)

Bibliography

Bibliographical references are resources that provide additional or helpful material but do not need to be understood or used to implement this document. Reference to these resources is made for informational use only.

- [B1] ANSI/IES RP-1-04: American National Standard Practice for Office Lighting.¹⁵
- [B2] Arias, M., D. G. Lamar, F. F. Linera, D. Balocco, A. A. Diallo, and J. Sebastian, “Design of a soft-switching asymmetrical half-bridge converter as second stage of an LED driver for street lighting application,” *IEEE Transactions on Power Electronics*, vol. 27, pp. 1608–1621, 2012.
- [B3] Baio, J., “Prevalence of Autism Spectrum Disorders Among Children Aged 8 Years—Autism and Developmental Disabilities Monitoring Network, 11 Sites, United States, 2010,” *Morbidity and Mortality Weekly Report, Surveillance Summaries*, vol. 63 (SS02), pp. 1–21, Mar. 2014.
- [B4] Beckstead, J. W., and P. R. Boyce, “Structural equation modeling in lighting research: An application to residential acceptance of new fluorescent lighting,” *Lighting Research and Technology*, vol. 24, pp. 189–201, 1992.
- [B5] Berman, S., D., D. Greenhouse, I. Bailey, R. Clear, and T. Raasch, “Human electroretinogram responses to video displays, fluorescent lighting, and other high frequency sources,” *Optometry and Vision Science*, vol. 68, pp. 645–662, Aug. 1991.
- [B6] Biddle, N., and H. McCormack, “Panic disorder and the procaine in penicillin G,” *The American Journal of Psychiatry*, vol. 145, p. 1317, Oct. 1988.
- [B7] BI EN 12464-1:2011, Light and Lighting—Lighting in Work Places—Part 1: Indoor work places.¹⁶
- [B8] Binnie, C. D., R. A. de Korte, and T. Wisman, “Fluorescent lighting and epilepsy,” *Epilepsia*, vol. 20, pp. 725–727, 1979.
- [B9] Brundrett, G. W., B. A. Griffiths, and P. R. Boyce, “Subjective response to a.c. and d.c. fluorescent lighting,” *Lighting Research and Technology*, vol. 5, pp. 160–162, 1973.
- [B10] Brundrett, G. W., “Human sensitivity to flicker,” *Lighting Research and Technology*, vol. 6, pp. 127–143, 1974.
- [B11] Bullough, J. D., K. Sweater Hickcox, T. R. Klein, A. Lok, and N. Narendran, “Detection and acceptability of stroboscopic effects from flicker,” *Lighting Research and Technology*, vol. 44, pp. 477–483, 11 Oct. 2012.
- [B12] Bullough, J. D., K. Sweater Hickcox, T. R. Klein, and N. Narendran, “Effects of flicker characteristics from solid-state lighting on detection, acceptability and comfort,” *Lighting Research and Technology*, vol. 43, pp. 337–348, Jul. 2011.
- [B13] Burns, S. A., A. E. Elsner, and M. R. Kreitz, “Analysis of nonlinearities in the flicker ERG,” *Optometry & Vision Science*, vol. 69, pp. 95–105, 1992.
- [B14] Cai, R., J. F. G. Cobben, J. M. A. Myrzik, J. H. Blom, and W. L. Kling, “Flicker Interaction Studies and Flickermeter Improvement,” Ph.D. diss., Eindhoven University of Technology (Technische Universiteit Eindhoven), 2009.

¹⁵ ANSI publications are available from the American National Standard Institute (<http://www.ansi.org>). IES publications are available from the Illuminating Engineering Society (<http://www.ies.org>).

¹⁶ BI standards are available from the British Standards Institute (<http://www.bsigroup.com/>).

- [B15] Cai, R., J. F. G. Cobben, J. M. A. Myrzik, J. H. Blom, and W. L. Kling, “Flicker response of different lamp types,” *IET Generation, Transmission & Distribution*, vol. 3, pp. 816–824, Sep. 2009.
- [B16] Campbell, F., and J. Robson, “Application of Fourier analysis to the visibility of gratings,” *Journal of Physiology*, vol. 197, pp. 551–566, 1968.
- [B17] Cates, C. A., “Visual Illusions Caused by the Stroboscopic Effects of Lighting on Industrial Machinery,” Master’s thesis, Army Material Command and Texas A&M University, 1971.
- [B18] Chen, W., S. N. Li, and S. Y. R. Hui, “A comparative study on the circuit topologies for offline passive light-emitting diode (LED) drivers with long lifetime & high efficiency,” *IEEE Energy Conversion Congress and Exposition*, pp. 724–730, 2010.
- [B19] Cheng, C., C. Chang, T. Chung, and F. Yang, “Design and implementation of a single-stage driver for supplying an LED street-lighting module with power-factor-corrections,” *IEEE Transactions on Power Electronics*, Early Access.
- [B20] Chou, H., Y.-S. Hwang, and J. J. Hwang, “An Adaptive Output Current Estimation Circuit for Primary-Side Controlled LED Driver,” *IEEE Transactions on Power Electronics*, vol. 28, pp. 4811–4819, 2013.
- [B21] CIE S 017/E:2011, ILV: International Lighting Vocabulary.¹⁷
- [B22] Collins, J. B., and R. G. Hopkinson, “Flicker Discomfort in the Lighting of Buildings,” *Transactions of the Illuminating Engineering Society*, London, vol. 19, pp. 135–158, 1954.
- [B23] de Bittencourt, P. R. M., “Photosensitivity: The magnitude of the problem,” *Epilepsia*, vol. 45, pp. 30–34, 2004.
- [B24] Debney, L. M., “Visual stimuli as migraine trigger factors,” *Progress in Migraine Research*, F. C. Rose, ed., pp. 30–54, 1984.
- [B25] de Lange, D. H., “Research into the dynamic nature of the human fovea-cortex systems with intermittent and modulated light. II. Phase shift in brightness and delay in color perception,” *Journal of the Optical Society of America*, vol. 48, pp. 784–789, 1958.
- [B26] de Lange Dzn, H., “Eye’s response at flicker fusion to square-wave modulation of a test field surrounded by a large steady field of equal mean luminance,” *Journal of the Optical Society of America*, vol. 51, p. 415, 1961.
- [B27] DeRoos, R. L., “Environmental health and safety concerns and energy conservation practices in academic institutions and hospitals,” *American Journal of Public Health*, vol. 68, pp. 1011–1015, Oct. 1978.
- [B28] DiLaura, D. L., K. W. Houser, R. G. Mistrick, and G. R. Steffy, *The Lighting Handbook*, 10th ed., New York: Illuminating Engineering Society, 2011.
- [B29] Drapela, J., and J. Slezinger, “A Flickermeter Based on Voltage Peak Detection Method—Part I: LabView Implementation,” *13th International Scientific Conference Electric Power Engineering*, Iasi, Romania, pp. 437–442, 2012.
- [B30] Eastman, A. A., and J. H. Campbell, “Stroboscopic and flicker effects from fluorescent lamps,” *Illuminating Engineering*, vol. 47, pp. 27–35, 1952.
- [B31] “ENERGY STAR Program Requirements for Integral LED Lamps,” ver. 1.4, 2011.
- [B32] Evans, J. E., I. C. Cuthill, and A. T. D. Bennett, “The effect of flicker from fluorescent lights on mate choice in captive birds,” *Animal Behaviour*, vol. 72, no. 2, pp. 393–400, 2006.
- [B33] Eysel, U. T., and U. Burandt, “Fluorescent tube light evokes flicker responses in visual neurons,” *Vision Research*, vol. 24, pp. 943–948, 1984.

¹⁷ CIE publications are available for the Commission Internationale de l’Eclairage (also known as the International Commission on Illumination) (<http://cie.co.at/>).

- [B34] Fenton, D. M., and R. Penney, "The effects of fluorescent and incandescent lighting on the repetitive behaviours of autistic and intellectually handicapped children," *Journal of Intellectual and Developmental Disability*, vol. 11, pp. 137–141, 1985.
- [B35] Fisher, R. S., G. F. A. Harding, G. Erba, G. L. Barkley, and A. Wilkins, "Photic- and pattern-induced seizures: A review for the Epilepsy Foundation of America working group," *Epilepsia*, vol. 46, pp. 1426–1441, Sep. 2005.
- [B36] Floyd, W. F., "Some effects of filament and fluorescent lighting on visual performance," *Light and Lighting*, vol. 49, p. 212, 1956.
- [B37] Fombonne, E., "Epidemiological surveys of autism and other pervasive developmental disorders: an update," *Journal of Autism and Developmental Disorders*, vol. 33, pp. 365–382, Aug. 2003.
- [B38] Frier, J. P., and A. J. Henderson, "Stroboscopic effect of high intensity discharge lamps," *Journal of the Illuminating Engineering Society*, vol. 3, 1973.
- [B39] Funatsuka, M., M. Fujita, S. Shirakawa, H. Oguni, and M. Osawa, "Analysis of photo-pattern sensitivity in patients with Pokemon-related symptoms," *Pediatric Neurology*, vol. 28, no. 1, pp. 28–36, 2003.
- [B40] Grandin, T., "Teaching ASD Children and Adults," Autism Research Institute's website under "Understanding Autism," 2002, http://www.autism.com/advocacy_grandin_teaching.
- [B41] Gu, L., X. Ruan, M. Xu, and K. Yao, "Means of eliminating electrolytic capacitor in AC/DC power supplies for LED lightings," *IEEE Transactions on Power Electronics*, vol. 27, pp. 1399–1408, 2009.
- [B42] Halpin, S. M., "Limits for Interharmonics in the 1–100-Hz Range Based on Lamp Flicker Considerations," *IEEE Transactions on Power Delivery*, vol. 22, pp. 270–276, Jan. 2007.
- [B43] Halpin, S. M., R. Bergeron, T. M. Blooming, R. F. Burch, L. E. Conrad, and T. S. Key, "Voltage and lamp flicker issues: Should the IEEE adopt the IEC approach?" *IEEE Transactions on Power Delivery*, vol. 18, pp. 1088–1097, Jul. 2003.
- [B44] Harding, G., A. J. Wilkins, G. Erba, G. L. Barkley, and R. S. Fisher, "Photic- and pattern induced seizures: Expert consensus of the epilepsy foundation of america working group," *Epilepsia*, vol. 46, pp. 1423–1441, Sep. 2005.
- [B45] Harding, G. F. A., and P. F. Harding, "Photosensitive epilepsy and image safety," *Applied Ergonomics*, 16 Oct. 2008.
- [B46] Harding, G. F. A., and P. Jeavons, *Photosensitive Epilepsy*. London: Mac Keith Press, 1994.
- [B47] Harle, D. E., and B. J. W. Evans, "The optometric correlates of migraine," *Ophthalmic & Physiological Optics*, vol. 24, pp. 369–383, Sep. 2004.
- [B48] Hart Jr., W. M., "The temporal responsiveness of vision," *Adler's Physiology of the eye, Clinical Application*. St. Louis, MO: The CV Mosby Company, 1987.
- [B49] Hazell, J., and A. Wilkins, "A contribution of fluorescent lighting to agoraphobia," *Psychological Medicine*, vol. 20, pp. 591–596, 1990.
- [B50] Hershberger, W. A., J. S. Jordan, and D. R. Lucas, "Visualizing the perisaccadic shift of spatiotopic coordinates," *Attention, Perception, & Psychophysics*, vol. 60, pp. 82–88, 1998.
- [B51] Hershberger, W., "Saccadic eye movements and the perception of visual direction," *Attention, Perception, & Psychophysics*, vol. 41, pp. 35–44, Jan. 1987.
- [B52] Hopkinson, R. G., and J. B. Collins, *The Ergonomics of Lighting*. London: MacDonald Technical and Scientific, 1970.
- [B53] Hu, Y., and M. M. Jovanovic, "LED driver with self-adaptive drive voltage," *IEEE Transactions on Power Electronics*, vol. 23, pp. 3116–3125, 2008.

- [B54] Hu, Y., L. Huber, and M. M. Jovanovic, "Single-stage, universal-input AC/DC LED driver with current-controlled variable PFC boost inductor," *IEEE Transactions on Power Electronics*, vol. 27, pp. 1579–1588, 2012.
- [B55] IEC 60825-1:2007, Safety of laser products—Part 1: Equipment classification and requirements.¹⁸
- [B56] IEC 61000-3-3:2013, Electromagnetic compatibility (EMC)—Part 3-3: Limits—Limitation of voltage changes, voltage fluctuations and flicker in public low-voltage supply systems, for equipment with rated current ≤ 16 A per phase and not subject to conditional connection.
- [B57] IEC 61000-4-15:2010, Electromagnetic compatibility (EMC)—Part 4-15: Testing and measurement techniques—Flickermeter—Functional and design specifications.
- [B58] IEC 62471:2006, Photobiological safety of lamps and lamp systems.
- [B59] IEEE Std 1453-2011, IEEE Recommended Practice—Adoption of IEC 61000-4-15:2010, Electromagnetic compatibility (EMC)—Testing and measurement techniques—Flickermeter—Functional and design specifications.¹⁹
- [B60] ISO/CIE 8995-1:2002: Lighting of work places—Part 1: Indoor.²⁰
- [B61] Jaen, E. M., E. M. Colombo, and C. F. Kirschbaum, "A simple visual task to assess flicker effects on visual performance," *Lighting Research and Technology*, vol. 43, pp. 457–471, 2011.
- [B62] Jaen, M., J. Sandoval, E. Colombo, and T. Troscianko, "Office workers visual performance and temporal modulation of fluorescent lighting," *LEUKOS*, vol. 1, pp. 27–46, 2005.
- [B63] Kelly, D. H., "Flicker," *Handbook of Sensory Physiology*, vol. 7, p. 273, 1972.
- [B64] Kelly, D. H., "Sine waves and flicker fusion," *Documenta Ophthalmologica*, vol. 18, pp. 16–35, 1964.
- [B65] Kelly, D. H., "Visual response to time-dependent stimuli, 1. Amplitude sensitivity measurements," *Journal of the Optical Society of America*, vol. 51, pp. 422–429, 1961.
- [B66] Kennedy, A., and W. S. Murray, "The effects of flicker on eye movement control," *The Quarterly Journal of Experimental Psychology—Section A: Human Experimental Psychology*, vol. 43, pp. 79–99, Feb. 1991.
- [B67] Kennedy, A., M. Brysbaert, and W. S. Murray, "The effects of intermittent illumination on a visual inspection task," *The Quarterly Journal of Experimental Psychology. A, Human Experimental Psychology*, vol. 51, no. 1, pp. 135–151, 1998.
- [B68] Kowacs, P., E. Piovesan, L. Werneck, H. Farneli, and H. Pereira da Silva, "Headache related to a specific screen flickering frequency band," *Cephalalgia*, vol. 24, pp. 408–410, May 2004.
- [B69] Küller, R., and T. Laike, "The impact of flicker from fluorescent lighting on well-being, performance and physiological arousal," *Ergonomics*, vol. 41, pp. 433–447, Apr. 1998.
- [B70] Kuneva, M., "European Commission Decision of 16 December 2009 laying down guidelines for the management of the Community Rapid Information System 'RAPEX' established under Article 12 and of the notification procedure established under Article 11 of Directive 2001/95/EC (the General Product Safety Directive)," *Official Journal of the European Union Part II (Non-legislative acts)*, vol. 53, p. L22/64, 2010.
- [B71] Lehman, B., A. Wilkins, S. Berman, M. Poplawski, and N. J. Miller, "Proposing measures of flicker in the low frequencies for lighting applications," presented at the Energy Conversion Congress and Exposition, Phoenix, AZ, 2011.
- [B72] Lehman, B., A. J. Wilkins, S. M. Berman, M. E. Poplawski, and N. J. Miller, "Proposing metrics of flicker in the low frequencies for lighting applications," *LEUKOS*, vol. 7, pp. 189–195, 2011.

¹⁸ IEC publications are available from the International Electrotechnical Commission (<http://www.iec.ch/>).

¹⁹ IEEE publications are available from The Institute of Electrical and Electronics Engineers (<http://standards.ieee.org/>).

²⁰ ISO publications are available from the International Organization for Standardization (<http://www.iso.org/>).

- [B73] Lehman, B., and A. J. Wilkins, "Designing to mitigate the effects of flicker in LED lighting," *IEEE Power Electronics Magazine*, Sep. 2014.
- [B74] Maddocks, S. A., A. R. Goldsmith, and I. C. Cuthill, "The influence of flicker rate on plasma corticosterone levels of European starlings, *Sturnus vulgaris*," *General and Comparative Endocrinology*, vol. 124, no. 3, pp. 315–320, 2001.
- [B75] Masakene, K. S., *Svetotechnika*, vol. 14, p. 5, 1968.
- [B76] Masi, M. G., L. Peretto, L. Rovait, and R. R. Ansari, "An attempt to understand flicker vertigo: changes in pupil size and choroidal blood flow under flickering conditions," *Proceedings of SPIE 7550, Ophthalmic Technologies XX*, pp. 75502G–75502G-7, 2010.
- [B77] Miller, N. J., M. P. Royer, and M. E. Poplawski, "CALiPER exploratory study: Recessed Troffer lighting," 2013, http://apps1.eere.energy.gov/buildings/publications/pdfs/ssl/caliper_recessed-troffer_2013.pdf.
- [B78] National Headache Foundation, "Light and Sensitivity," 25 Oct. 2007, <http://www.headaches.org/2007/10/25/light-and-sensitivity>.
- [B79] Noge, Y., and J.-I. Itoh, "Linear PFC regulator for LED lighting with the multi-level structure and low voltage MOSFETs," *IEEE Applied Power Electronics Conference and Exposition*, pp. 3311–3317, 2014.
- [B80] Okumura, A., K. Aso, and T. A. Ishikawa, "Follow-up survey on seizures induced by animated cartoon TV program 'Pocket Monster,'" *Epilepsia*, vol. 45, no. 4, pp. 377–383, 2004.
- [B81] Perz, M., I. Vogels, and D. Sekulovski, "Evaluating the visibility of temporal light artifacts," *Lux Europa 2013: 12th European Lighting Conference*, Jagiellonian University Krakow, Poland, 2013.
- [B82] Perz, M., I. Vogels, D. Sekulovski, L. Wang, Y. Tu, and I. E. J. Heynderickx, "Modeling the visibility of the stroboscopic effect occurring in temporally modulated light systems," *Lighting Research and Technology*, 2014.
- [B83] Poplawski, M., and N. J. Miller, "Exploring flicker in solid state lighting: What you might find, and how to deal with it," *Illuminating Engineering Society of North America Annual Conference*, pp. 97–115, 2011.
- [B84] Poplawski, M. E., B. C. Dixon, B. W. Russell, and M. L. Paget, "Exploring flicker in SSL integral replacement lamps," PNNL-20391, 2011.
- [B85] Poplawski, M. E., "Exploring Flicker & LEDs," *Voices for SSL Efficiency 2010*, 2010.
- [B86] Rand, D., B. Lehman, and A. Shteynberg, "Issues, Models and Solutions for Triac Modulated Phase Dimming of LED Lamps," *Proceedings of IEEE Power Electronics Specialists Conference*, 2007, pp. 1398–1404.
- [B87] Rash, C. E., "Awareness of causes and symptoms of flicker vertigo can limit ill effects," *Human Factors & Aviation Medicine*, vol. 51, p. 1–6, 2004.
- [B88] Rea, M. S., and M. J. Ouellette, "Table-tennis under high intensity discharge (HID) lighting," *Journal of the Illuminating Engineering Society*, vol. 17, pp. 29–35, 1988.
- [B89] Rey, P., and J.-P. Rey, "Les effets compares de deux eclairages fluorescents sur une tache visuelle et des tests de 'fatigue,'" *Ergonomics*, vol. 6, p. 393, 1963.
- [B90] Rider, G., D. van Aken, C. van de Sman, J. Mason, and X. Chen, "Framework model of product risk assessment," *International Journal of Injury Control and Safety Promotion*, vol. 16, pp. 73–80, Jun. 2009.
- [B91] Ridley, J. R., and J. Channing, *Safety at Work*. Oxford, England: Butterworth-Heinemann, 2003.
- [B92] Roberts, J. E., and A. J. Wilkins, "Flicker can be perceived during saccades at frequencies in excess of 1 kHz," *Lighting Research and Technology*, vol. 45, pp. 124–132, 2012.

- [B93] Rosenblat, H., “Panic attacks triggered by photic simulation,” *The American Journal of Psychiatry*, vol. 146, pp. 801–802, Jun. 1989.
- [B94] Sandahl, L. J., T. L. Gilbride, M. R. Ledbetter, H. E. Steward, and C. Calwell, “Compact fluorescent lighting in America: Lessons learned on the way to market,” Pacific Northwest National Laboratory, Richland, WA, 2006.
- [B95] Scientific Committee on Emerging and Newly Identified Health Risks (SCENIHR), “Scientific Opinion on Light Sensitivity,” 23 Sep. 2008.
- [B96] Shady, S., D. I. A. MacLeod, and H. S. Fisher, “Adaptation from invisible flicker,” *Proceedings of the National Academy of Sciences U.S.A.*, vol. 101, pp. 5170–5173, 2004.
- [B97] Sharp, C., “New types of incandescent lamps,” *Transactions of the American Institute of Electrical Engineers*, vol. 25, pp. 815–847, 1907.
- [B98] Shepherd, A. J., “Visual stimuli, light and lighting are common triggers of migraine and headache,” *Journal of Light & Visual Environment*, vol. 34, pp. 94–100, 2010.
- [B99] Shteynberg, A., et al., “Apparatus, method, and system for providing AC line power to lighting devices,” U.S. Patent no. 8324840, 2012.
- [B100] Smedley, A. R. D., A. R. Webb, and A. J. Wilkins, “Potential of wind turbines to elicit seizures under various meteorological conditions,” *Epilepsia*, vol. 51, pp. 1146–1151, Nov. 2009.
- [B101] Smith, R. A., “Luminance-dependent changes in mesopic visual contrast sensitivity,” *Journal of Physiology*, vol. 230, pp. 115–135, 1973.
- [B102] Smyth, V. O., and A. L. Winter, “The EFG in migraine,” *Electroencephalography and Clinical Neurophysiology*, vol. 16, pp. 194–202, Feb. 1964.
- [B103] Stone, P. T., “Fluorescent lighting and health,” *Lighting Research and Technology*, vol. 24, pp. 55–61, 1992.
- [B104] Stovner, L., K. Hagen, R. Jensen, Z. Katsarava, R. Lipton, A. Scher, T. Steiner, and J.-A. Zwart, “The global burden of headache: a documentation of headache prevalence and disability worldwide,” *Cephalalgia*, vol. 27, pp. 193–210, Mar. 2007.
- [B105] Texas Instruments, TPS92411EVM-001 development kit user’s guide, <http://www.ti.com/lit/ug/slvu965a/slvu965a.pdf>.
- [B106] U.S. Department of Energy (DOE), ed., “Energy savings potential of solid-state lighting in general illumination applications 2010 to 2030,” prepared by Navigant Consulting, Washington, D.C., 2012.
- [B107] Veitch, J. A., and S. L. McColl, “Modulation of fluorescent light: Flicker rate and light source effects on visual performance and visual comfort,” *Lighting Research and Technology*, vol. 27, p. 243, 1995.
- [B108] “Vocabulary Catalog List Detail,” 8 Jan 2013, http://ofmpub.epa.gov/sor_internet/registry/termreg/searchandretrieve/glossariesandkeywordlists/search.do?details=&glossaryName=IRIS%20Glossary.
- [B109] Vogels, I., D. Sekulovski, and M. Perz, “Visible artefacts of LEDs,” *27th Session of the CIE*, Sun City, South Africa, 2011.
- [B110] Waters, W. E., and P. J. O’Connor, “Prevalance of migraine,” *Journal of Neurology, Neurosurgery & Psychiatry*, vol. 38, pp. 613–616, Jun. 1975.
- [B111] Watts, F. N., and A. J. Wilkins, “The role of provocative visual stimuli in agoraphobia,” *Psychological Medicine*, vol. 19, pp. 875–885, Nov. 1989.
- [B112] Wilkins, A., “Intermittent illumination from visual display units and fluorescent lighting affects movements of the eyes across text,” *Human Factors*, vol. 28, pp. 75–81, Feb. 1986.
- [B113] Wilkins, A., *Visual Stress*. Oxford, England: Oxford University Press, 1995.

- [B114] Wilkins, A., C. E. Darby, and C. D. Binnie, "Neurophysiological aspects of pattern-sensitive epilepsy," *Brain*, vol. 102, pp. 1–25, 1979.
- [B115] Wilkins, A. J., and C. Clark, "Modulation of light from fluorescent lamps," *Lighting Research and Technology*, vol. 22, pp. 103–109, 1990.
- [B116] Wilkins, A. J., I. Nimmo-Smith, A. I. Slater, and L. Bedocs, "Fluorescent lighting, headaches, and eyestrain," *Lighting Research and Technology*, vol. 21, p. 11, 1989.
- [B117] Wilkins, A., J. Veitch, and B. Lehman, "LED lighting flicker and potential health concerns: IEEE standard PAR1789 update," *Energy Conversion Congress and Exposition (ECCE)*, Atlanta, GA, pp. 171–178, 2010.
- [B118] Williams, J. G., J. P. T. Higgins, and C. E. G. Brayne, "Systematic review of prevalence studies of autism spectrum disorders," *Archives of Disease in Childhood*, vol. 91, pp. 8–15, Jan. 2006.
- [B119] Xie, X., J. Wang, C. Zhao, Q. Lu, and S. Liu, "A novel output current estimation and regulation circuit for primary side controlled high power factor single-stage flyback LED driver," *IEEE Transactions on Power Electronics*, vol. 27, pp. 4602–4612, 2012.
- [B120] Zaccaria, J., and M. E. Bitterman, "The effect of fluorescent flicker on visual efficiency," *Journal of Applied Psychology*, vol. 36, pp. 413–416, Dec. 1952.
- [B121] Zhang, F., J. Ni, and Y. Yu, "High power factor AC-DC LED driver with film capacitors," *IEEE Transactions on Power Electronics*, vol. 27, pp. 4831–4840, 2013.

www.Lisungroup.com

www.Lisungroup.cc

Consensus

WE BUILD IT.

www.Lisungroup.cc

Connect with us on:



Facebook: <https://www.facebook.com/ieeesa>



Twitter: @ieeesa



LinkedIn: <http://www.linkedin.com/groups/IEEESA-Official-IEEE-Standards-Association-1791118>



IEEE-SA Standards Insight blog: <http://standardsinsight.com>



YouTube: IEEE-SA Channel